



■ Features :

- Universal AC input / Full range (up to 305VAC)
- Built-in active PFC function
- High efficiency up to 94%
- Protections: Short circuit / Over current / Over voltage / Over temperature
- Cooling by free air convection
- OCP point adjustable through output cable or internal potentiometer
- IP67 / IP65 design for indoor or outdoor installations
- Three in one dimming function (1~10Vdc or PWM signal or resistance)
- Suitable for LED lighting and street lighting applications
- Compliance to worldwide safety regulations for lighting
- Suitable for dry / damp / wet locations
- 5 years warranty (Note.9)



HLG-150H-12 Blank : IP67 rated. Cable for I/O connection.
 A : IP65 rated. Output voltage and constant current level can be adjusted through internal potentiometer.
 B : IP67 rated. Constant current level adjustable through output cable with 1~10Vdc or 10V PWM signal or resistance.
 D (option) : IP67 rated. Timer dimming function, contact MEAN WELL for details.

SPECIFICATION

| MODEL | HLG-150H-12 | HLG-150H-15 | HLG-150H-20 | HLG-150H-24 | HLG-150H-30 | HLG-150H-36 | HLG-150H-42 | HLG-150H-48 | HLG-150H-54 | |
|-------------------------|---|--|--|----------------|-----------------|-----------------|-------------|----------------|-------------|-------------|
| OUTPUT | DC VOLTAGE | 12V | 15V | 20V | 24V | 30V | 36V | 42V | 48V | 54V |
| | RATED CURRENT | 12.5A | 10A | 7.5A | 6.3A | 5A | 4.2A | 3.6A | 3.2A | 2.8A |
| | RATED POWER | 150W | 150W | 150W | 151.2W | 150W | 151.2W | 151.2W | 153.6W | 151.2W |
| | RIPPLE & NOISE (max.) Note.2 | 150mVp-p | 150mVp-p | 150mVp-p | 150mVp-p | 200mVp-p | 200mVp-p | 200mVp-p | 200mVp-p | 200mVp-p |
| | VOLTAGE ADJ. RANGE Note.5 | 10.8 ~ 13.5V | 13.5 ~ 17V | 17 ~ 22V | 22 ~ 27V | 27 ~ 33V | 33 ~ 40V | 38 ~ 46V | 43 ~ 53V | 49 ~ 58V |
| | CURRENT ADJ. RANGE | Can be adjusted by internal potentiometer or through output cable | | | | | | | | |
| | | 7.5 ~ 12.5A | 6 ~ 10A | 4.5 ~ 7.5A | 3.8 ~ 6.3A | 3 ~ 5A | 2.5 ~ 4.2A | 2.16 ~ 3.6A | 1.92 ~ 3.2A | 1.68 ~ 2.8A |
| | VOLTAGE TOLERANCE Note.3 | ±2.5% | ±2.0% | ±1.0% | ±1.0% | ±1.0% | ±1.0% | ±1.0% | ±1.0% | ±1.0% |
| | LINE REGULATION | ±0.5% | ±0.5% | ±0.5% | ±0.5% | ±0.5% | ±0.5% | ±0.5% | ±0.5% | ±0.5% |
| | LOAD REGULATION | ±2.0% | ±1.5% | ±1.0% | ±0.5% | ±0.5% | ±0.5% | ±0.5% | ±0.5% | ±0.5% |
| SETUP, RISE TIME Note.7 | 2500ms, 80ms at full load | | 230VAC / 115VAC ; B type 2500ms, 200ms at 95% load | | | 230VAC / 115VAC | | | | |
| HOLD UP TIME (Typ.) | 16ms at full load | | 230VAC / 115VAC | | | | | | | |
| INPUT | VOLTAGE RANGE Note.4 | 90 ~ 305VAC | | 127 ~ 431VDC | | | | | | |
| | FREQUENCY RANGE | 47 ~ 63Hz | | | | | | | | |
| | POWER FACTOR (Typ.) | PF>0.98/115VAC, PF>0.95/230VAC, PF>0.92/277VAC at full load (Please refer to "Power Factor Characteristic" curve) | | | | | | | | |
| | EFFICIENCY (Typ.) | 91.5% | 92% | 93% | 93% | 93.5% | 93.5% | 94% | 94% | 94% |
| | AC CURRENT (Typ.) | 1.7A / 115VAC | | 0.75A / 230VAC | | 0.7A / 277VAC | | | | |
| | INRUSH CURRENT (Typ.) | COLD START 75A/230VAC | | | | | | | | |
| LEAKAGE CURRENT | <0.75mA / 277VAC | | | | | | | | | |
| PROTECTION | OVER CURRENT | 95 ~ 108% | | | | | | | | |
| | | Protection type : Constant current limiting, recovers automatically after fault condition is removed | | | | | | | | |
| | SHORT CIRCUIT | Constant current limiting, recovers automatically after fault condition is removed | | | | | | | | |
| | OVER VOLTAGE | 14 ~ 17V | 18 ~ 21V | 23 ~ 27V | 28 ~ 34V | 34 ~ 38V | 41 ~ 46V | 47 ~ 53V | 54 ~ 60V | 59 ~ 65V |
| | Protection type : Shut down o/p voltage with auto-recovery or re-power on to recovery | | | | | | | | | |
| OVER TEMPERATURE | 100°C ±10°C (RTH2) | | | | | | | | | |
| | Protection type : Shut down o/p voltage, recovers automatically after temperature goes down | | | | | | | | | |
| ENVIRONMENT | WORKING TEMP. | -40 ~ +70°C (Refer to "Derating Curve") | | | | | | | | |
| | WORKING HUMIDITY | 20 ~ 95% RH non-condensing | | | | | | | | |
| | STORAGE TEMP., HUMIDITY | -40 ~ +80°C, 10 ~ 95% RH | | | | | | | | |
| | TEMP. COEFFICIENT | ±0.03%/°C (0 ~ 50°C) | | | | | | | | |
| | VIBRATION | 10 ~ 500Hz, 5G 12min./1cycle, period for 72min. each along X, Y, Z axes | | | | | | | | |
| SAFETY & EMC | SAFETY STANDARDS Note.6 | UL8750, EN61347-1, EN61347-2-13 independent, J61347-1, J61347-2-13, IP65 or IP67 approved ; Design refer to UL60950-1, TUV EN60950-1 | | | | | | | | |
| | WITHSTAND VOLTAGE | I/P-O/P:3.75KVAC | | | I/P-FG:1.88KVAC | | | O/P-FG:0.5KVAC | | |
| | ISOLATION RESISTANCE | I/P-O/P, I/P-FG, O/P-FG:100M Ohms / 500VDC / 25°C / 70% RH | | | | | | | | |
| | EMC EMISSION | Compliance to EN55015, EN55022 (CISPR22) Class B, EN61000-3-2 Class C (≥60% load) ; EN61000-3-3 | | | | | | | | |
| | EMC IMMUNITY | Compliance to EN61000-4-2,3,4,5,6,8,11, EN61547, EN55024, heavy industry level (surge 4KV), criteria A | | | | | | | | |
| OTHERS | MTBF | 192.2Khrs min. MIL-HDBK-217F (25°C) | | | | | | | | |
| | DIMENSION | 228*68*38.8mm | | | | | | | | |
| | PACKING | 1.15Kg; 12pcs/14.8Kg/0.74CUFT | | | | | | | | |

NOTE

1. All parameters NOT specially mentioned are measured at 230VAC input, rated load and 25°C of ambient temperature.
2. Ripple & noise are measured at 20MHz of bandwidth by using a 12" twisted pair-wire terminated with a 0.1uf & 47uf parallel capacitor.
3. Tolerance : includes set up tolerance, line regulation and load regulation.
4. Derating may be needed under low input voltages. Please check the static characteristics for more details.
5. Type A and type C only.
6. Safety and EMC design refer to EN60598-1, subject 8750(UL), CNS15233, GB7000.1, FCC part18.
7. Length of set up time is measured at cold first start. Turning ON/OFF the power supply may lead to increase of the set up time.
8. The power supply is considered as a component that will be operated in combination with final equipment. Since EMC performance will be affected by the complete installation, the final equipment manufacturers must re-qualify EMC Directive on the complete installation again.
9. Refer to warranty statement.

Mechanical Specification

Case No.954D

Unit:mm

Blank:(HLG-150H)

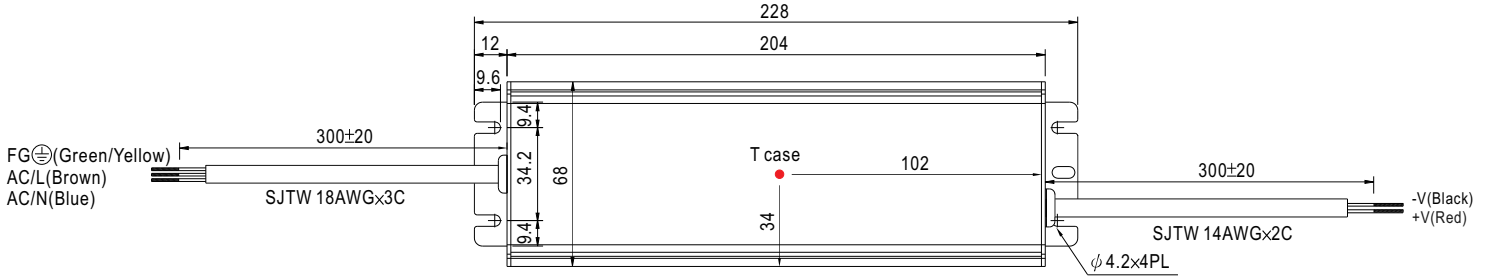

※ T case: Max. Case Temperature.

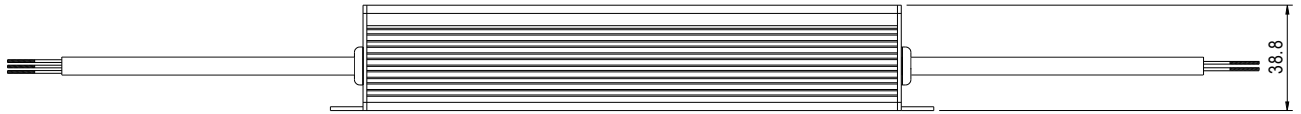

※IP67 rated. Cable for I/O connection.

A Type:(HLG-150H- _A)

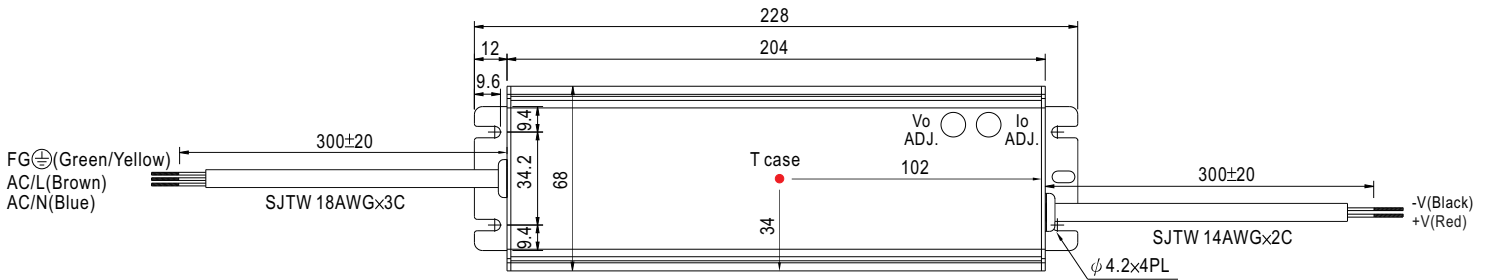

※ T case: Max. Case Temperature.



※ IP65 rated. Output voltage and constant current level can be adjusted through internal potentiometer.
(Can access by removing the rubber stopper on the case.)

B Type:(HLG-150H- _B)

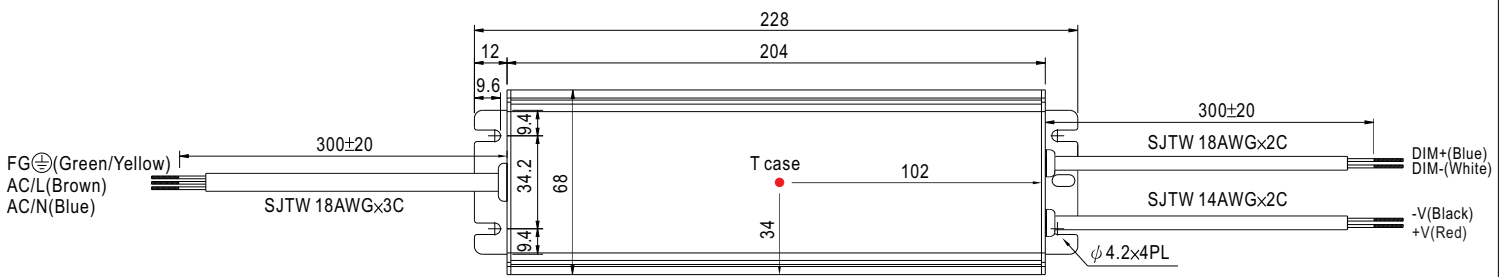

※ T case: Max. Case Temperature.



D Type(option):(HLG-150H-_D)

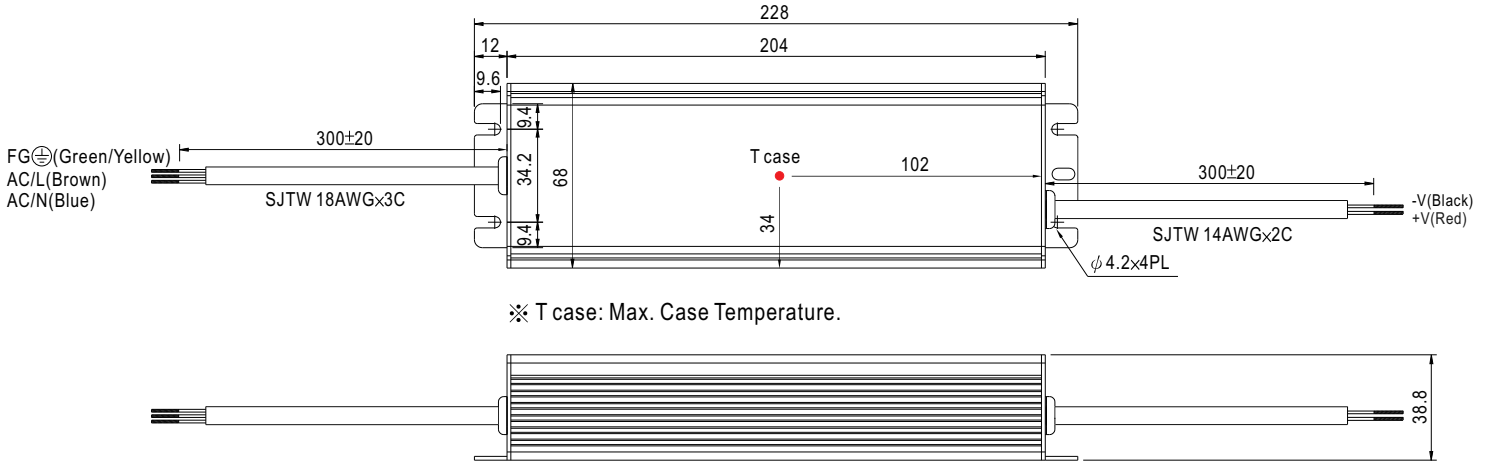

※ T case: Max. Case Temperature.

※ IP67 rated. Timer dimming function, contact MEAN WELL for details.

■ Block Diagram

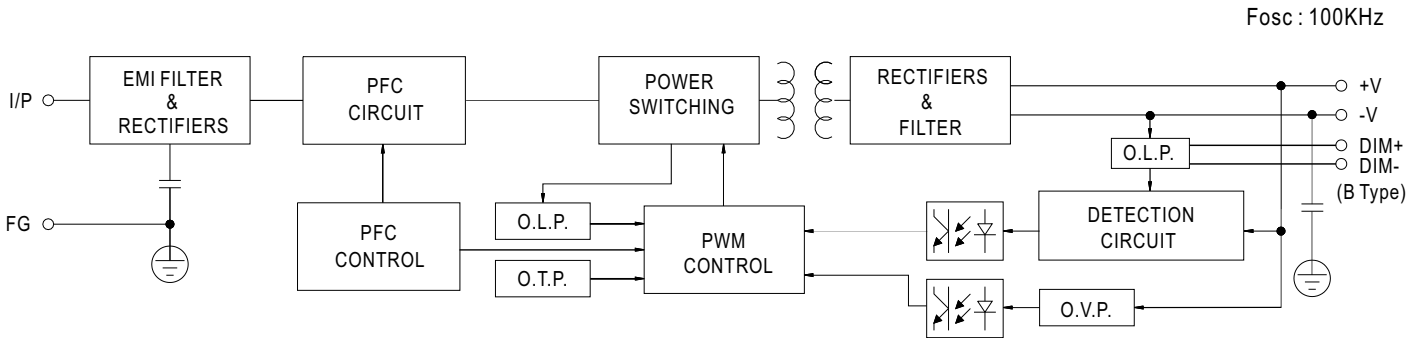

■ Derating Curve

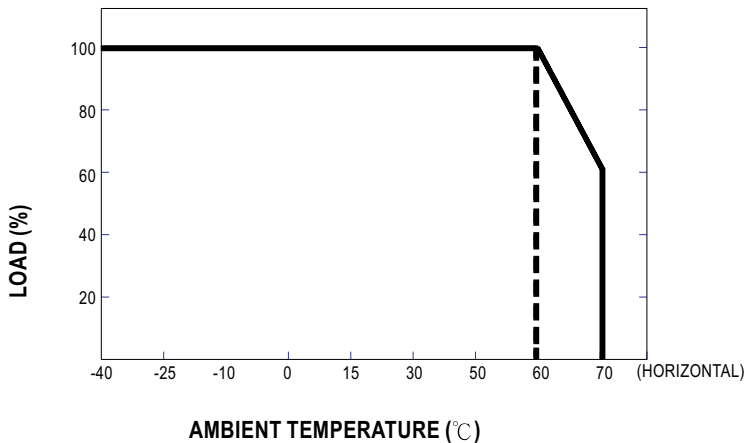

■ Static Characteristics

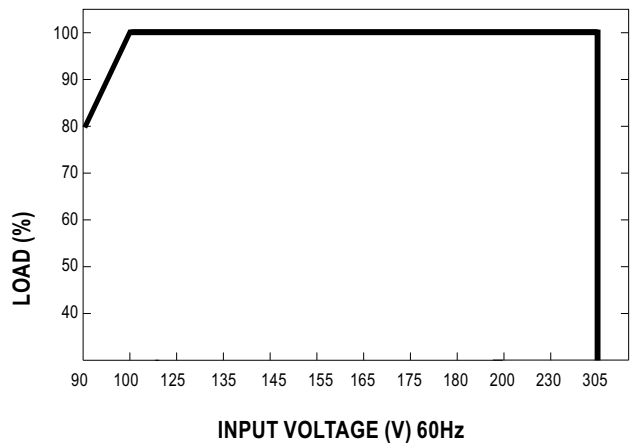

Power Factor Characteristic

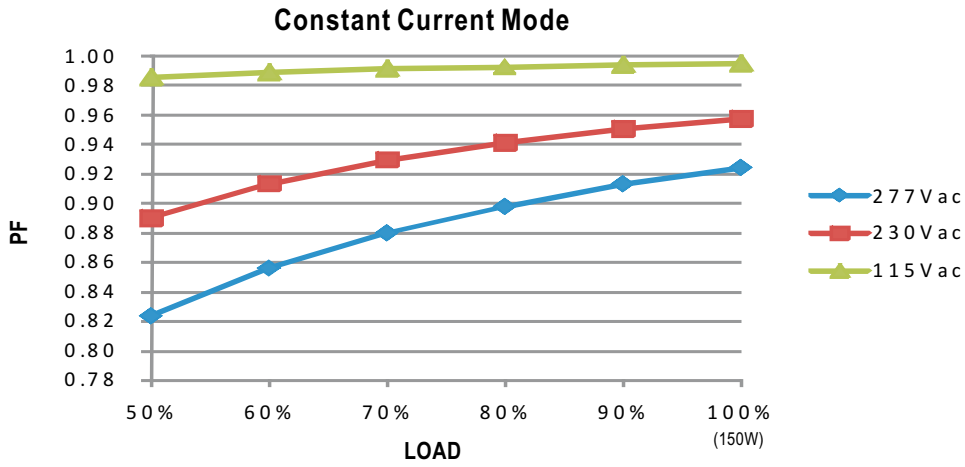

EFFICIENCY vs LOAD (48V Model)

HLG-150H series possess superior working efficiency that up to 94% can be reached in field applications.

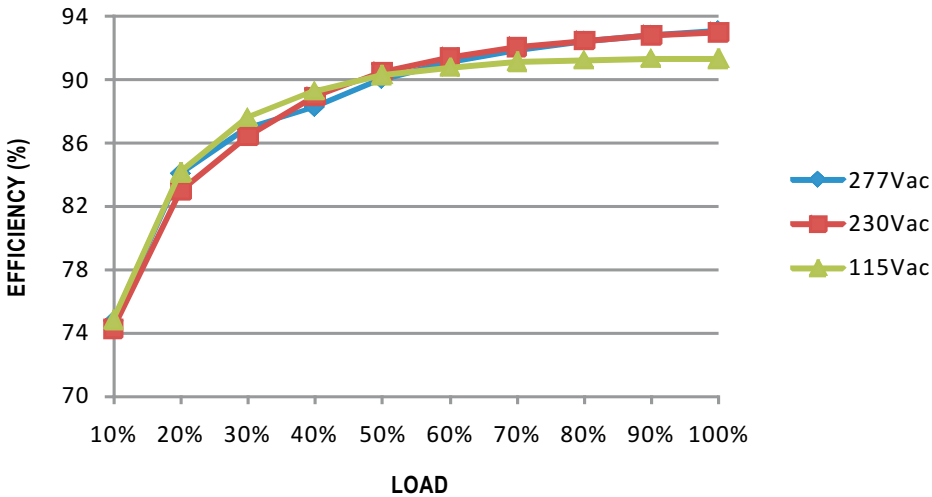

DRIVING METHODS OF LED MODULE

There are two major kinds of LED drive method "direct drive" and "with LED driver".

A typical LED power supply may either work in "constant voltage mode (CV) or constant current mode (CC)" to drive the LEDs.

Mean Well's LED power supply with CV+ CC characteristic can be operated at both CV mode (with LED driver, at area (A) and CC mode (direct drive, at area (B)).

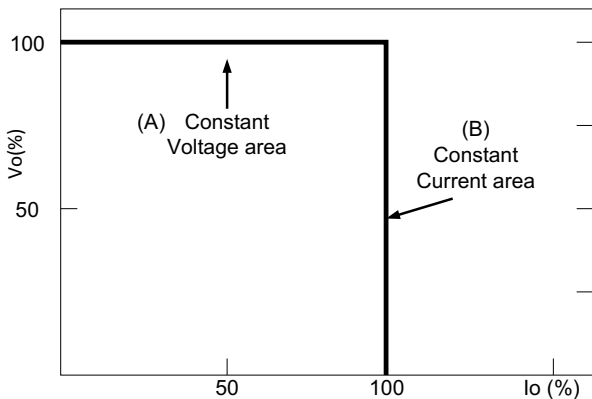

DIMMING OPERATION

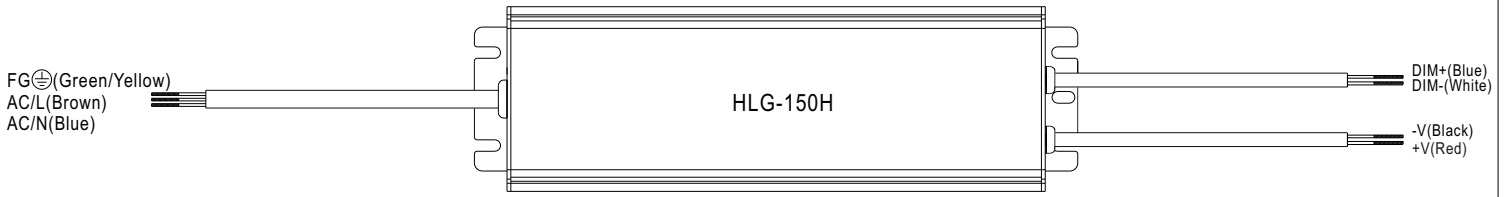

※ Built-in 3 in 1 dimming function, IP67 rated. Output constant current level can be adjusted through output cable by connecting a resistance or 1 ~ 10Vdc or 10V PWM signal between DIM+ and DIM-.

※ Please DO NOT connect "DIM-" to "-V".

※ Reference resistance value for output current adjustment (Typical)

| | | | | | | | | | | | |
|-----------------------------|------|------|------|------|------|------|------|------|------|-------|-----------|
| Resistance value | 10KΩ | 20KΩ | 30KΩ | 40KΩ | 50KΩ | 60KΩ | 70KΩ | 80KΩ | 90KΩ | 100KΩ | OPEN |
| Percentage of rated current | 10% | 20% | 30% | 40% | 50% | 60% | 70% | 80% | 90% | 100% | 102%~108% |

※ 1 ~ 10V dimming function for output current adjustment (Typical)

| | | | | | | | | | | | |
|-----------------------------|-----|-----|-----|-----|-----|-----|-----|-----|-----|------|-----------|
| Dimming value | 1V | 2V | 3V | 4V | 5V | 6V | 7V | 8V | 9V | 10V | OPEN |
| Percentage of rated current | 10% | 20% | 30% | 40% | 50% | 60% | 70% | 80% | 90% | 100% | 102%~108% |

※ 10V PWM signal for output current adjustment (Typical): Frequency range :100HZ ~ 3KHz

| | | | | | | | | | | | |
|-----------------------------|-----|-----|-----|-----|-----|-----|-----|-----|-----|------|-----------|
| Duty value | 10% | 20% | 30% | 40% | 50% | 60% | 70% | 80% | 90% | 100% | OPEN |
| Percentage of rated current | 10% | 20% | 30% | 40% | 50% | 60% | 70% | 80% | 90% | 100% | 102%~108% |

※Using the built-in dimming function on B-type model can't turn the lighting fixture totally dark. Please refer to the connection method below to achieve 0% brightness of the lighting fixture connecting to the LED power supply unit.

Dimming connection diagram for turning the lighting fixture ON/OFF :

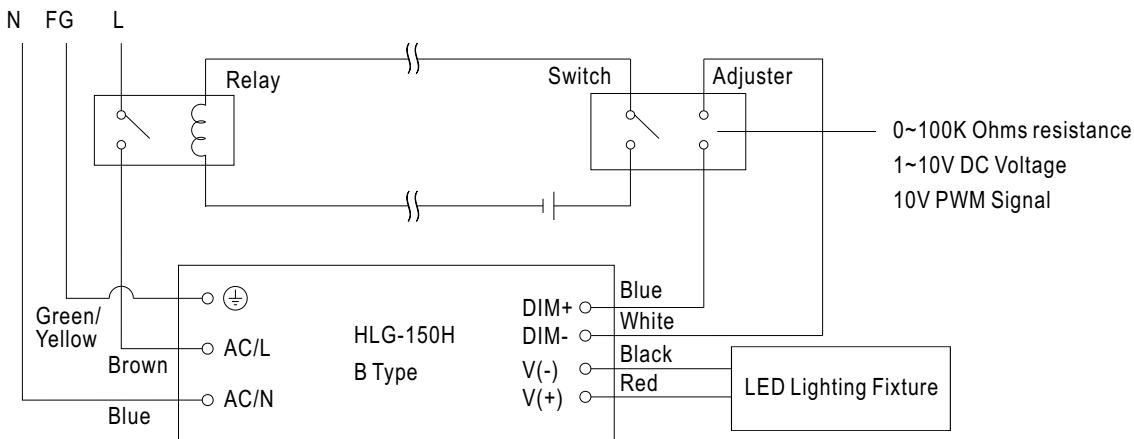

Using a switch and relay can turn ON/OFF the lighting fixture.

1. Output constant current level can be adjusted through output cable by connecting a resistance or 1~10Vdc or 10V PWM signal between DIM+ and DIM-.
2. The LED lighting fixture can be turned ON/OFF by the switch.

WATERPROOF CONNECTION

Waterproof connector

Waterproof connector can be assembled on the output cable of HLG-150H to operate in dry/wet/damp or outdoor environment.

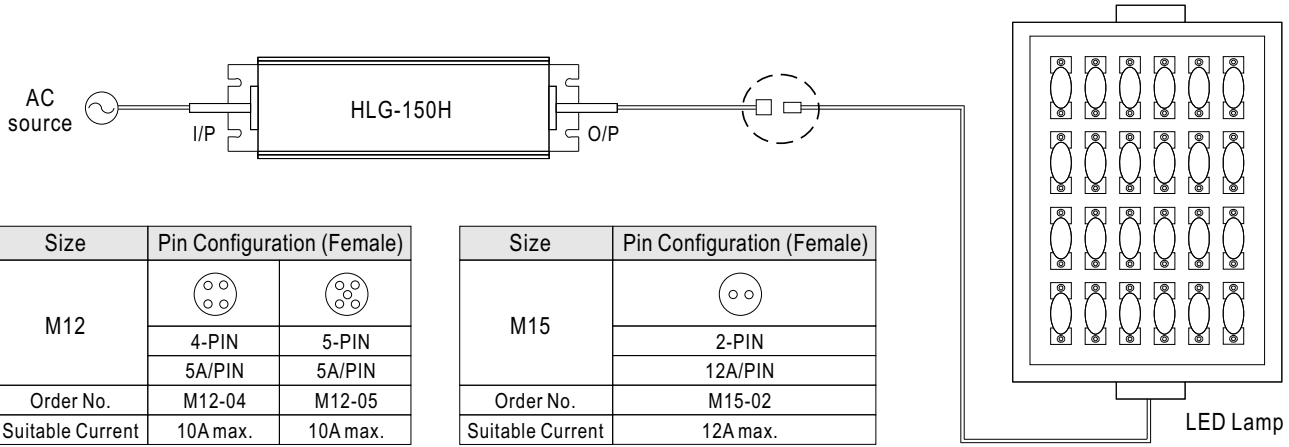

Cable Joiner

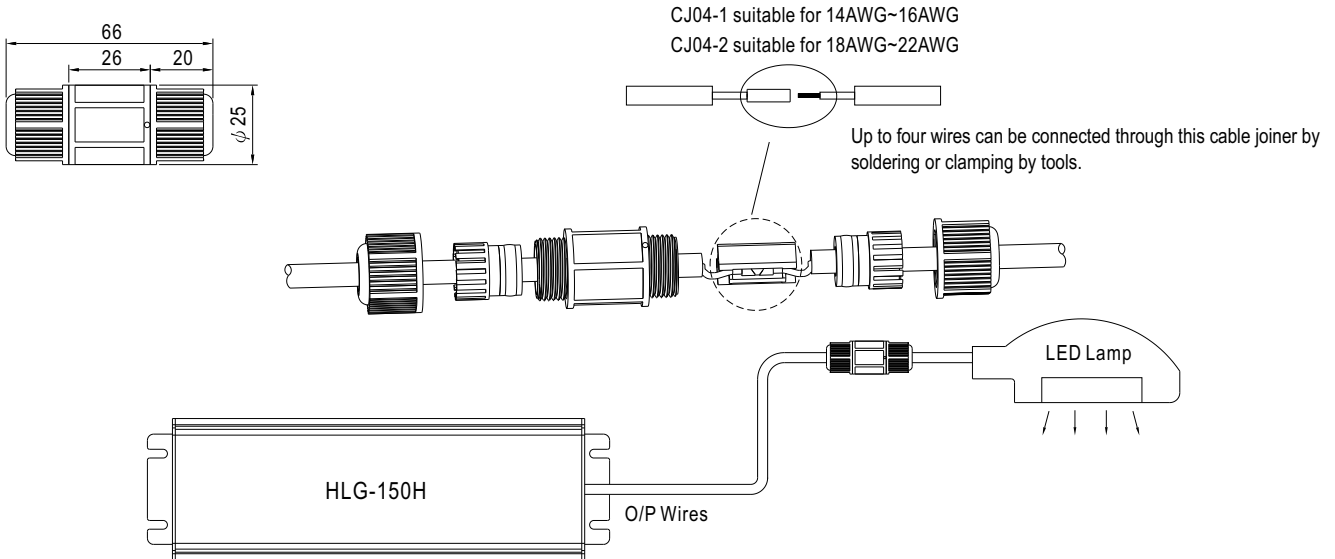

※CJ04 cable joiner can be purchased independently for user's own assembly.

MEAN WELL order No. : CJ04-1, CJ04-2.

Junction Box(Optional)

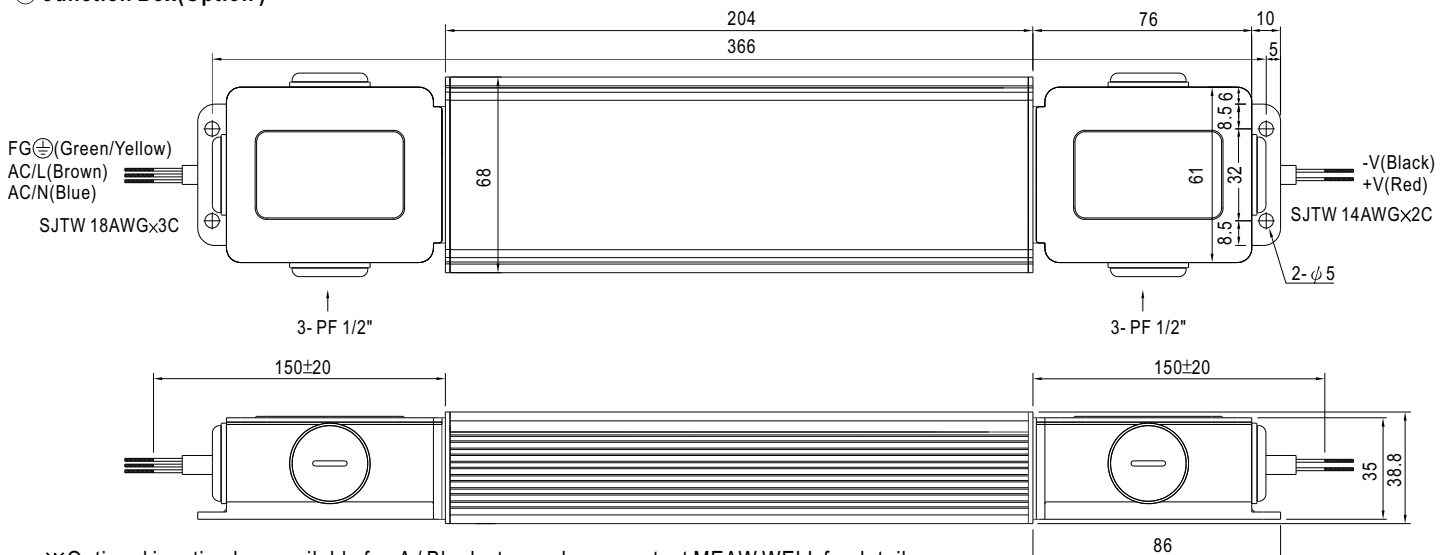

※Optional junction box available for A / Blank - type, please contact MEAW WELL for details.