



## 300W Railway Single Output DC-DC Converter

# RSD-300 series



### ■ Features :

- Compliance to BS EN/EN50155 and BS EN/EN45545-2 railway standard
- 2:1 wide input range
- Protections: Short circuit / Overload / Over voltage / Over temperature / Input reverse polarity
- 4000VDC I/O isolation
- Cooling by free air convection
- Half encapsulated
- Built-in constant current limiting circuit
- 1U low profile 40mm
- All using 105°C long life electrolytic capacitors
- LED indicator for power on
- 100% full load burn-in test
- 3 years warranty



### SPECIFICATION

MODEL		RSD-300B-5	RSD-300B-12	RSD-300B-24	RSD-300B-48	RSD-300C-5	RSD-300C-12	RSD-300C-24	RSD-300C-48	
OUTPUT	DC VOLTAGE	5V	12V	24V	48V	5V	12V	24V	48V	
	RATED CURRENT	42A	22.5A	11.3A	5.7A	42A	25A	12.5A	6.3A	
	CURRENT RANGE	0 ~ 42A	0 ~ 22.5A	0 ~ 11.3A	0 ~ 5.7A	0 ~ 42A	0 ~ 25A	0 ~ 12.5A	0 ~ 6.3A	
	RATED POWER	210W	270W	271.2W	273.6W	210W	300W	300W	302.4W	
	RIPPLE & NOISE (max.) Note.2	100mVp-p	120mVp-p	150mVp-p	180mVp-p	100mVp-p	120mVp-p	150mVp-p	180mVp-p	
	VOLTAGE TOLERANCE Note.3	± 2.0%	± 2.0%	± 2.0%	± 2.0%	± 2.0%	± 2.0%	± 2.0%	± 2.0%	
	LINE REGULATION	± 0.5%	± 0.3%	± 0.2%	± 0.5%	± 0.5%	± 0.3%	± 0.2%	± 0.5%	
	LOAD REGULATION	± 1.0%	± 1.0%	± 1.0%	± 1.0%	± 1.0%	± 1.0%	± 1.0%	± 1.0%	
	SETUP, RISE TIME	800ms, 50ms at full load								
HOLD UP TIME (Typ.)	Please refer to page 5,6 Hold up Time( Load de-rating curve )									
INPUT	VOLTAGE RANGE	CONTINUOUS 16.8 ~ 31.2VDC				33.6 ~ 62.4VDC				
		1 SEC. 14.4 ~ 33.6VDC				28.8 ~ 67.2VDC				
	EFFICIENCY (Typ.)	89%	89.5%	90%	91.5%	90.5%	91%	91.5%	92%	
	DC CURRENT (Typ.)	9.7A/24V	14.6A/24V	14.6A/24V	14.6A/24V	4.8A/48V	7.2A/48V	7.2A/48V	7.2A/48V	
	INRUSH CURRENT (Typ.)	45A/24VDC				45A/48VDC				
INTERRUPTION OF VOLTAGE SUPPLY	EN50155:2007-B/C- type comply with S1 level @ full load, comply with S2 level @ 70% load EN50155:2017-Comply with S1 level									
PROTECTION	OVERLOAD	105 ~ 135% rated output power Protection type : Constant current limiting, recovers automatically after fault condition is removed								
	OVER VOLTAGE	5.75 ~ 7V	13.8 ~ 16.2V	27.6 ~ 32.4V	55.2 ~ 64.8V	5.75 ~ 7V	13.8 ~ 16.2V	27.6 ~ 32.4V	55.2 ~ 64.8V	
	OVER TEMPERATURE	Shut down o/p voltage, recovers automatically after temperature goes down								
ENVIRONMENT	WORKING TEMP.	-40 ~ +55°C (no derating) ; +70°C @ 60% load by free air convection ; +70°C no derating with external base plate, TX class compliance								
	WORKING HUMIDITY	5 ~ 95% RH non-condensing								
	STORAGE TEMP.	-40 ~ +85°C								
	TEMP. COEFFICIENT	± 0.03%/°C (0 ~ 55°C)								
	VIBRATION	10 ~ 500Hz, 5G 10min./1cycle, 60min. each along X, Y, Z axes ; Mounting : compliance to IEC61373								
	OPERATING ALTITUDE	5000 meters								
SAFETY & EMC (Note 5)	SAFETY STANDARDS	IEC 62368-1, UL 62368-1, AS/NZS 62368-1, EAC TP TC 004 approved, Design refer to BS EN/EN62368-1								
	WITHSTAND VOLTAGE	I/P-O/P:4KVDC I/P-FG:2.5KVDC O/P-FG:2.5KVDC								
	ISOLATION RESISTANCE	I/P-O/P, I/P-FG, O/P-FG:100M Ohms / 500VDC / 25°C / 70% RH								
	EMC EMISSION	Compliance to BS EN/EN55032 (CISPR32) Conduction Emission: Class A, Radiation Emission: Class B, EAC TP TC 020								
	EMC IMMUNITY	Compliance to BS EN/EN61000-4-2,3,4,5,6,8, light industry level, criteria A, EAC TP TC 020								
	RAILWAY STANDARD	BS EN/EN50155 / IEC60571 including IEC61373 for shock & vibration,BS EN/EN50121-3-2 for EMC;BS EN/EN45545-2 for fire protection								
OTHERS	MTBF	130.7K hrs min. MIL-HDBK-217F (25°C)								
	DIMENSION	216*96.5*40mm (L*W*H)								
	PACKING	1.19Kg ; 12pcs/15.3Kg/0.97CUFT								
NOTE	<ol style="list-style-type: none"> <li>1. All parameters NOT specially mentioned are measured at 24,48VDC input, rated load and 25°C of ambient temperature.</li> <li>2. Ripple &amp; noise are measured at 20MHz of bandwidth by using a 12" twisted pair-wire terminated with a 0.1uf &amp; 47uf parallel capacitor.</li> <li>3. Tolerance : includes set up tolerance, line regulation and load regulation.</li> <li>4. Strongly recommended that external output capacitance should not exceed 5000uF. (Only for: RSD-300-5 / -12)</li> <li>5. The power supply is considered a component which will be installed into a final equipment. All the EMC tests are been executed by mounting the unit on a 360mm*360mm metal plate with 1mm of thickness. The final equipment must be re-confirmed that it still meets EMC directives. For guidance on how to perform these EMC tests, please refer to "EMI testing of component power supplies." (as available on <a href="http://www.meanwell.com">http://www.meanwell.com</a>)</li> <li>6. The ambient temperature derating of 3.5°C/1000m with fanless models and of 5°C/1000m with fan models for operating altitude higher than 2000m(6500ft).</li> </ol>									



## 300W Railway Single Output DC-DC Converter

# RSD-300 series



### ■ Features :

- Compliance to BS EN/EN50155 and BS EN/EN45545-2 railway standard
- 2:1 wide input range
- Protections: Short circuit / Overload / Over voltage / Over temperature / Input reverse polarity
- 4000VDC I/O isolation
- Cooling by free air convection
- Half encapsulated
- Built-in constant current limiting circuit
- 1U low profile 40mm
- All using 105°C long life electrolytic capacitors
- LED indicator for power on
- 100% full load burn-in test
- 3 years warranty



### SPECIFICATION

MODEL		RSD-300D-5	RSD-300D-12	RSD-300D-24	RSD-300D-48	RSD-300E-5	RSD-300E-12	RSD-300E-24	RSD-300E-48	
OUTPUT	DC VOLTAGE	5V	12V	24V	48V	5V	12V	24V	48V	
	RATED CURRENT	42A	25A	12.5A	6.3A	42A	25A	12.5A	6.3A	
	CURRENT RANGE	0 ~ 42A	0 ~ 25A	0 ~ 12.5A	0 ~ 6.3A	0 ~ 42A	0 ~ 25A	0 ~ 12.5A	0 ~ 6.3A	
	RATED POWER	210W	300W	300W	302.4W	210W	300W	300W	302.4W	
	RIPPLE & NOISE (max.) Note.2	100mVp-p	120mVp-p	150mVp-p	180mVp-p	100mVp-p	120mVp-p	150mVp-p	180mVp-p	
	VOLTAGE TOLERANCE Note.3	± 2.0%	± 2.0%	± 2.0%	± 2.0%	± 2.0%	± 2.0%	± 2.0%	± 2.0%	
	LINE REGULATION	± 0.5%	± 0.2%	± 0.2%	± 0.5%	± 0.5%	± 0.3%	± 0.2%	± 0.5%	
	LOAD REGULATION	± 1.0%	± 1.0%	± 1.0%	± 1.0%	± 1.0%	± 1.0%	± 1.0%	± 1.0%	
	SETUP, RISE TIME	800ms, 50ms at full load								
HOLD UP TIME (Typ.)	Please refer to page 5,6 Hold up Time( Load de-rating curve )									
INPUT	VOLTAGE RANGE	CONTINUOUS 67.2 ~ 143VDC				25.2 ~ 46.8VDC				
		1 SEC. 57.6 ~ 154VDC				21.6 ~ 50.4VDC				
	EFFICIENCY (Typ.)	90%	91.5%	91.5%	91.5%	88%	90%	91%	91%	
	DC CURRENT (Typ.)	2.1A/110V	3.1A/110V	3.1A/110V	3.1A/110V	6.5A/36V	9.2A/36V	9.2A/36V	9.2A/36V	
	INRUSH CURRENT (Typ.)	45A/110VDC				45A/36VDC				
INTERRUPTION OF VOLTAGE SUPPLY	EN50155:2007-D-type and E-5 comply with S2 level @ full load; other E- type comply with S1 level @ full load, comply with S2 level @ 70% load EN50155:2017-Comply with S1 level									
PROTECTION	OVERLOAD	105 ~ 135% rated output power Protection type : Constant current limiting, recovers automatically after fault condition is removed								
	OVER VOLTAGE	5.75 ~ 7V	13.8 ~ 16.2V	27.6 ~ 32.4V	55.2 ~ 64.8V	5.75 ~ 7V	13.8 ~ 16.2V	27.6 ~ 32.4V	55.2 ~ 64.8V	
	OVER TEMPERATURE	Shut down o/p voltage, recovers automatically after temperature goes down								
ENVIRONMENT	WORKING TEMP.	-40 ~ +55°C (no derating) ; +70°C @ 60% load by free air convection ; +70°C no derating with external base plate, TX class compliance								
	WORKING HUMIDITY	5 ~ 95% RH non-condensing								
	STORAGE TEMP.	-40 ~ +85°C								
	TEMP. COEFFICIENT	± 0.03%/°C (0 ~ 55°C)								
	VIBRATION	10 ~ 500Hz, 5G 10min./1cycle, 60min. each along X, Y, Z axes ; Mounting : compliance to IEC61373								
	OPERATING ALTITUDE	5000 meters								
SAFETY & EMC (Note 5)	SAFETY STANDARDS	IEC 62368-1, UL 62368-1, AS/NZS 62368-1, EAC TP TC 004 approved, Design refer to BS EN/EN62368-1								
	WITHSTAND VOLTAGE	I/P-O/P:4KVDC I/P-FG:2.5KVDC O/P-FG:2.5KVDC								
	ISOLATION RESISTANCE	I/P-O/P, I/P-FG, O/P-FG:100M Ohms / 500VDC / 25°C / 70% RH								
	EMC EMISSION	Compliance to BS EN/EN55032 (CISPR32) Conduction Emission: Class A, Radiation Emission: Class B, EAC TP TC 020								
	EMC IMMUNITY	Compliance to BS EN/EN61000-4-2,3,4,5,6,8, light industry level, criteria A, EAC TP TC 020								
	RAILWAY STANDARD	BS EN/EN50155 / IEC60571 including IEC61373 for shock & vibration, BS EN/EN50121-3-2 for EMC ; BS EN/EN45545-2 for fire protection								
OTHERS	MTBF	130.7K hrs min. MIL-HDBK-217F (25°C)								
	DIMENSION	216*96.5*40mm (L*W*H)								
	PACKING	1.19Kg ; 12pcs/15.3Kg/0.97CUFT								
NOTE	<ol style="list-style-type: none"> <li>1. All parameters NOT specially mentioned are measured at 36,110VDC input, rated load and 25°C of ambient temperature.</li> <li>2. Ripple &amp; noise are measured at 20MHz of bandwidth by using a 12" twisted pair-wire terminated with a 0.1uF &amp; 47uF parallel capacitor.</li> <li>3. Tolerance : includes set up tolerance, line regulation and load regulation.</li> <li>4. Strongly recommended that external output capacitance should not exceed 5000uF. (Only for: RSD-300-5 / -12)</li> <li>5. The power supply is considered a component which will be installed into a final equipment. All the EMC tests are been executed by mounting the unit on a 360mm*360mm metal plate with 1mm of thickness. The final equipment must be re-confirmed that it still meets EMC directives. For guidance on how to perform these EMC tests, please refer to "EMI testing of component power supplies." (as available on <a href="http://www.meanwell.com">http://www.meanwell.com</a>)</li> <li>6. The ambient temperature derating of 3.5°C/1000m with fanless models and of 5°C/1000m with fan models for operating altitude higher than 2000m(6500ft).</li> </ol>									



## 300W Railway Single Output DC-DC Converter

# RSD-300 series



### ■ Features :

- Compliance to BS EN/EN50155 and BS EN/EN45545-2 railway standard
- 2:1 wide input range
- Protections: Short circuit / Overload / Over voltage / Over temperature / Input reverse polarity
- 4000VDC I/O isolation
- Cooling by free air convection
- Half encapsulated
- Built-in constant current limiting circuit
- 1U low profile 40mm
- All using 105°C long life electrolytic capacitors
- LED indicator for power on
- 100% full load burn-in test
- 3 years warranty



### SPECIFICATION

MODEL	RSD-300F-5		RSD-300F-12		RSD-300F-24		RSD-300F-48		
OUTPUT	DC VOLTAGE	5V		12V		24V		48V	
	RATED CURRENT	42A		25A		12.5A		6.3A	
	CURRENT RANGE	0 ~ 42A		0 ~ 25A		0 ~ 12.5A		0 ~ 6.3A	
	RATED POWER	210W		300W		300W		302.4W	
	RIPPLE & NOISE (max.) Note.2	100mVp-p		120mVp-p		150mVp-p		180mVp-p	
	VOLTAGE TOLERANCE Note.3	± 2.0%		± 2.0%		± 2.0%		± 2.0%	
	LINE REGULATION	± 0.5%		± 0.3%		± 0.2%		± 0.5%	
	LOAD REGULATION	± 1.0%		± 1.0%		± 1.0%		± 1.0%	
	SETUP, RISE TIME	800ms, 50ms at full load							
HOLD UP TIME (Typ.)	Please refer to page 5,6 Hold up Time( Load de-rating curve )								
INPUT	VOLTAGE RANGE	CONTINUOUS	50.4 ~ 93.6VDC						
		1 SEC.	43.2 ~ 100.8VDC						
	EFFICIENCY (Typ.)		89%	91%	91%	91.5%			
	DC CURRENT (Typ.)		3.25A/72V	4.6A/72V	4.6A/72V	4.6A/72V			
	INRUSH CURRENT (Typ.)		45A/72VDC						
PROTECTION	OVERLOAD		105 ~ 135% rated output power Protection type : Constant current limiting, recovers automatically after fault condition is removed						
	OVER VOLTAGE		5.75 ~ 7V	13.8 ~ 16.2V	27.6 ~ 32.4V	55.2 ~ 64.8V			
	OVER TEMPERATURE		Shut down o/p voltage, recovers automatically after temperature goes down						
ENVIRONMENT	WORKING TEMP.		-40 ~ +55°C (no derating) ; +70°C @ 60% load by free air convection ; +70°C no derating with external base plate, TX class compliance						
	WORKING HUMIDITY		5 ~ 95% RH non-condensing						
	STORAGE TEMP.		-40 ~ +85°C						
	TEMP. COEFFICIENT		± 0.03%/°C (0 ~ 55°C)						
	VIBRATION		10 ~ 500Hz, 5G 10min./1cycle, 60min. each along X, Y, Z axes ; Mounting : compliance to IEC61373						
	OPERATING ALTITUDE		5000 meters						
SAFETY & EMC (Note 5)	SAFETY STANDARDS		IEC 62368-1, UL 62368-1, AS/NZS 62368-1, EAC TP TC 004 approved, Design refer to BS EN/EN62368-1						
	WITHSTAND VOLTAGE		I/P-O/P:4KVDC I/P-FG:2.5KVDC O/P-FG:2.5KVDC						
	ISOLATION RESISTANCE		I/P-O/P, I/P-FG, O/P-FG:100M Ohms / 500VDC / 25°C / 70% RH						
	EMC EMISSION		Compliance to BS EN/EN55032 (CISPR32) Conduction Emission: Class A, Radiation Emission: Class B, EAC TP TC 020						
	EMC IMMUNITY		Compliance to BS EN/EN61000-4-2,3,4,5,6,8, light industry level, criteria A, EAC TP TC 020						
	RAILWAY STANDARD		BS EN/EN50155 / IEC60571 including IEC61373 for shock & vibration, BS EN/EN50121-3-2 for EMC ; BS EN/EN45545-2 for fire protection						
OTHERS	MTBF		130.7K hrs min. MIL-HDBK-217F (25°C)						
	DIMENSION		216*96.5*40mm (L*W*H)						
	PACKING		1.19Kg ; 12pcs/15.3Kg/0.97CUFT						
NOTE	<ol style="list-style-type: none"> <li>1. All parameters NOT specially mentioned are measured at 72VDC input, rated load and 25°C of ambient temperature.</li> <li>2. Ripple &amp; noise are measured at 20MHz of bandwidth by using a 12" twisted pair-wire terminated with a 0.1uF &amp; 47uF parallel capacitor.</li> <li>3. Tolerance : includes set up tolerance, line regulation and load regulation.</li> <li>4. Strongly recommended that external output capacitance should not exceed 5000uF. (Only for: RSD-300-5 / -12)</li> <li>5. The power supply is considered a component which will be installed into a final equipment. All the EMC tests are been executed by mounting the unit on a 360mm*360mm metal plate with 1mm of thickness. The final equipment must be re-confirmed that it still meets EMC directives. For guidance on how to perform these EMC tests, please refer to "EMI testing of component power supplies." (as available on <a href="http://www.meanwell.com">http://www.meanwell.com</a>)</li> <li>6. The ambient temperature derating of 3.5°C/1000m with fanless models and of 5°C/1000m with fan models for operating altitude higher than 2000m(6500ft).</li> </ol> <p>※ Product Liability Disclaimer : For detailed information, please refer to <a href="https://www.meanwell.com/serviceDisclaimer.aspx">https://www.meanwell.com/serviceDisclaimer.aspx</a></p>								

**Mechanical Specification**

Case No.205 Unit:mm

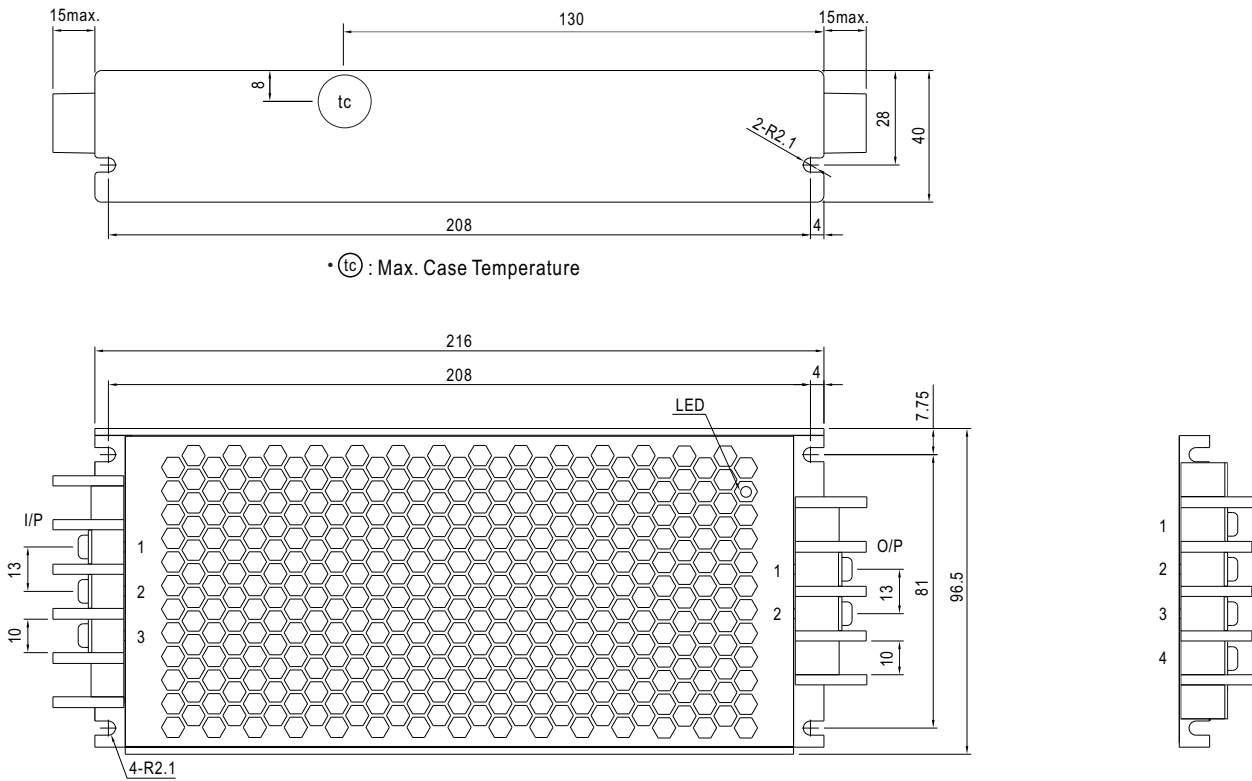

• (tc) : Max. Case Temperature

Input Terminal Pin No. Assignment :

Pin No.	Assignment
1	DC INPUT V+
2	DC INPUT V-
3	FG $\perp$

Output Terminal Pin No. Assignment :  
(For 12V, 24V, 48V)

Pin No.	Assignment
1	DC OUTPUT -V
2	DC OUTPUT +V

(For 5V)

Pin No.	Assignment
1,2	DC OUTPUT -V
3,4	DC OUTPUT +V

**Block Diagram**

fosc : 130KHz

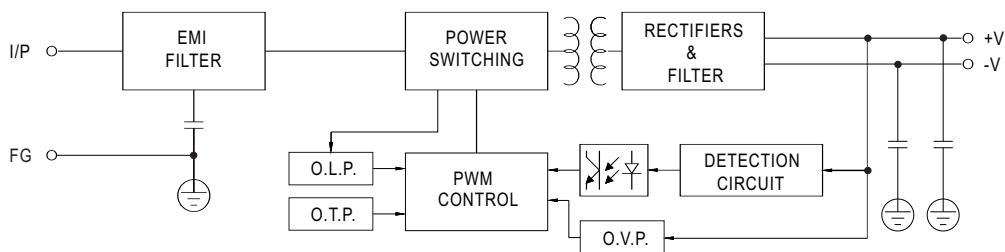

**Input Fuse**

There are one or two fuses connected in series to the positive input line, which are used to protect against abnormal surge. Fuse specifications of each model are shown as below.

Type	Fuse Type	Reference and Rating
B	Fast	Littelfuse 257, 30A, 32V
C	Time-Lag	Conquer UDA-A, 16A, 250V
D	Time-Lag	Conquer UDA-A, 8A, 250V
E	Time-Lag	Conquer UDA-A, 20A, 250V
F	Time-Lag	Conquer UDA-A, 10A, 250V



### Input Reverse Polarity Protection

There is a MOSFET connected in series to the negative input line. If the input polarity is connected reversely, the MOSFET opens and there will be no output to protect the unit.

### Input Range and Transient Ability

The series has a wide range input capability. Within  $\pm 30\%$  of rated input voltage, it can be executed at full-load operation and operate properly; with  $\pm 40\%$  of rated input voltage, it can withstand that for 1 second.

### Input Under-Voltage Protection

If input voltage drops below  $V_{imin}$ , the internal control IC shuts down and there is no output voltage. It recovers automatically when input voltage reaches above  $V_{imin}$ , please refer to the curve below.

RSD-300B-24

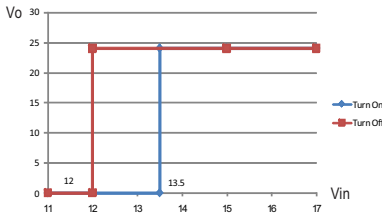

RSD-300C-24

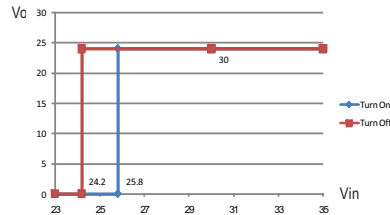

RSD-300D-24

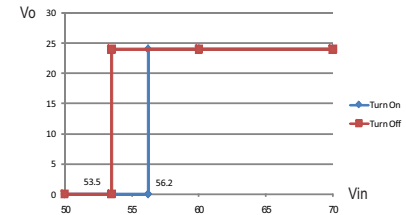

RSD-300E-24

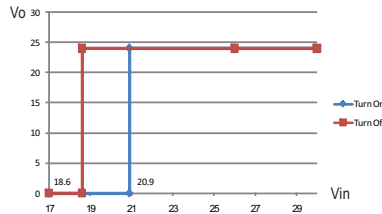

RSD-300F-24

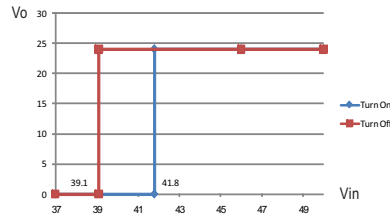

### Inrush Current

Inrush current is suppressed by a resistor during the initial start-up, and then the resistor is bypassed by a MOSFET to reduce power consumption after accomplishing the start-up.

### Hold-up Time

- EN50155: 2007 version - D and F and E-5 types are in compliance with S2 level, while B and C and E types are in compliance with S1 level at full load output condition. To fulfil the requirements of S2 level, B and C and E types require de-rating their output load to 70%, please refer to the curve diagrams below.

RSD-300B-5

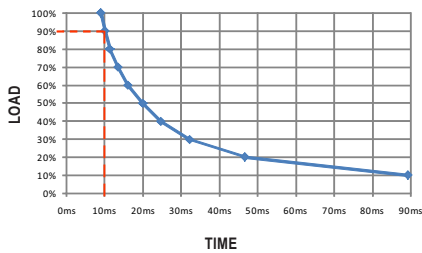

RSD-300B-12

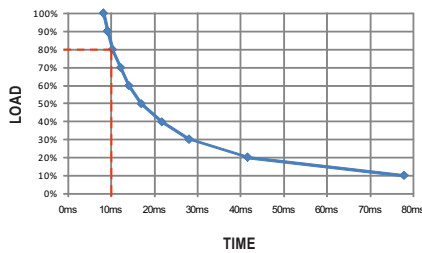

RSD-300B-24

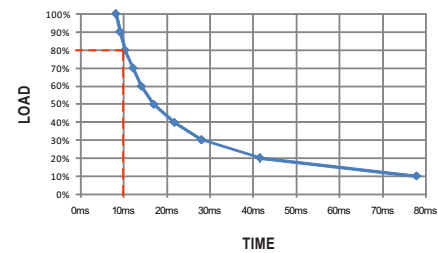

RSD-300B-48

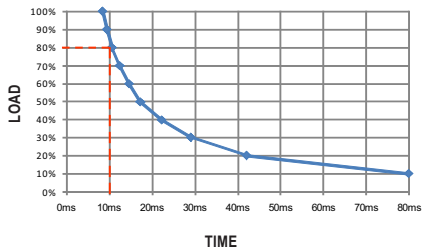

RSD-300C-5

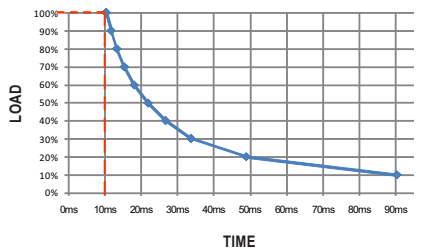

RSD-300C-12

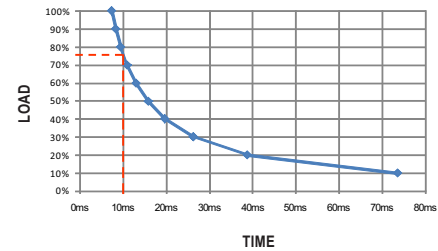

RSD-300C-24

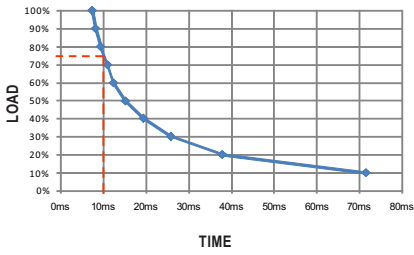

RSD-300C-48

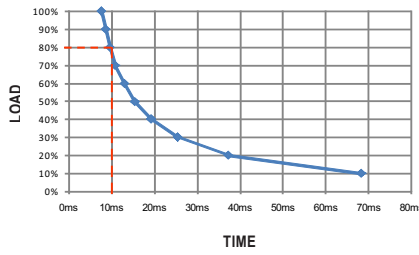

RSD-300E-12

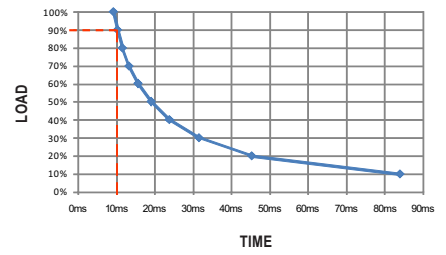

RSD-300E-24

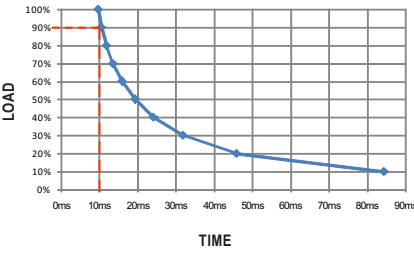

RSD-300E-48

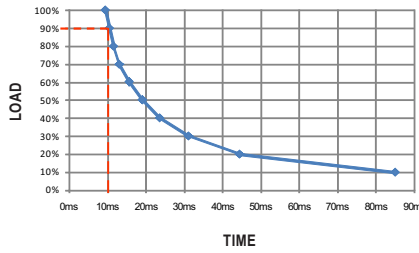

• EN50155: 2017 version - Comply with S1 level

### Output Voltage Adjustment

This function is optional, which the standard product does not have it. If you do need the function, please contact

### Efficiency vs Load & Vin Curve

The efficiency vs load & Vin curves of each model are shown as below.

RSD-300B-5

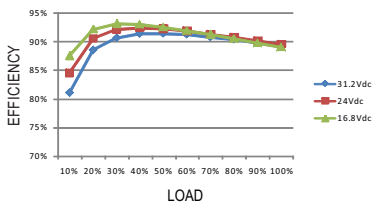

RSD-300B-12

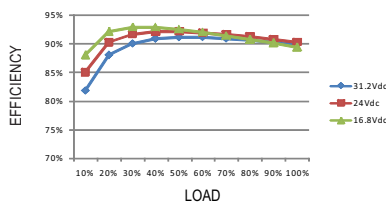

RSD-300B-24

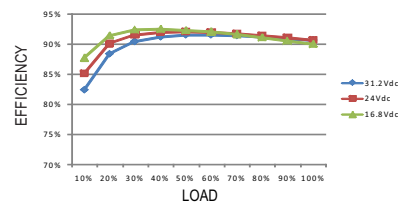

RSD-300B-48

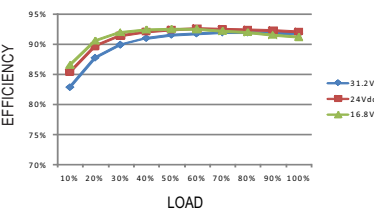

RSD-300C-5

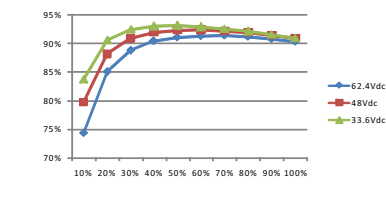

RSD-300C-12

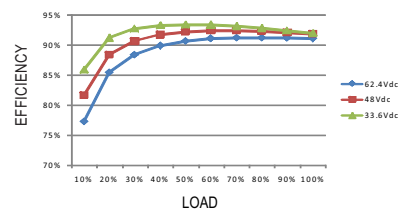

RSD-300C-24

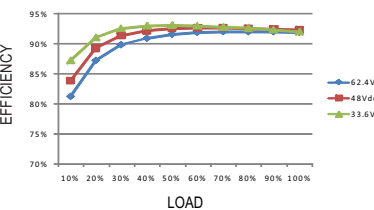

RSD-300C-48

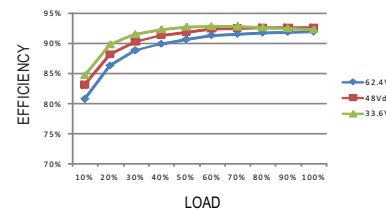

RSD-300D-5

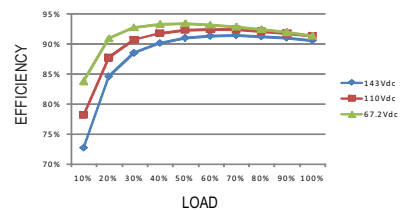

RSD-300D-12

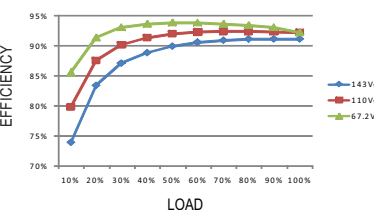

RSD-300D-24

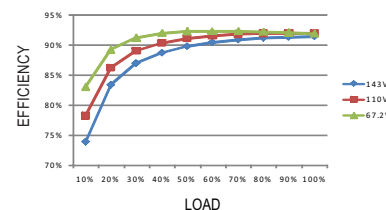

RSD-300D-48

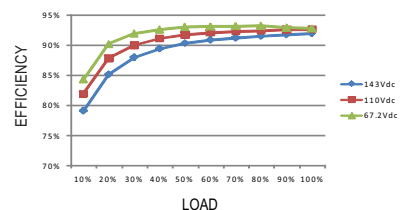



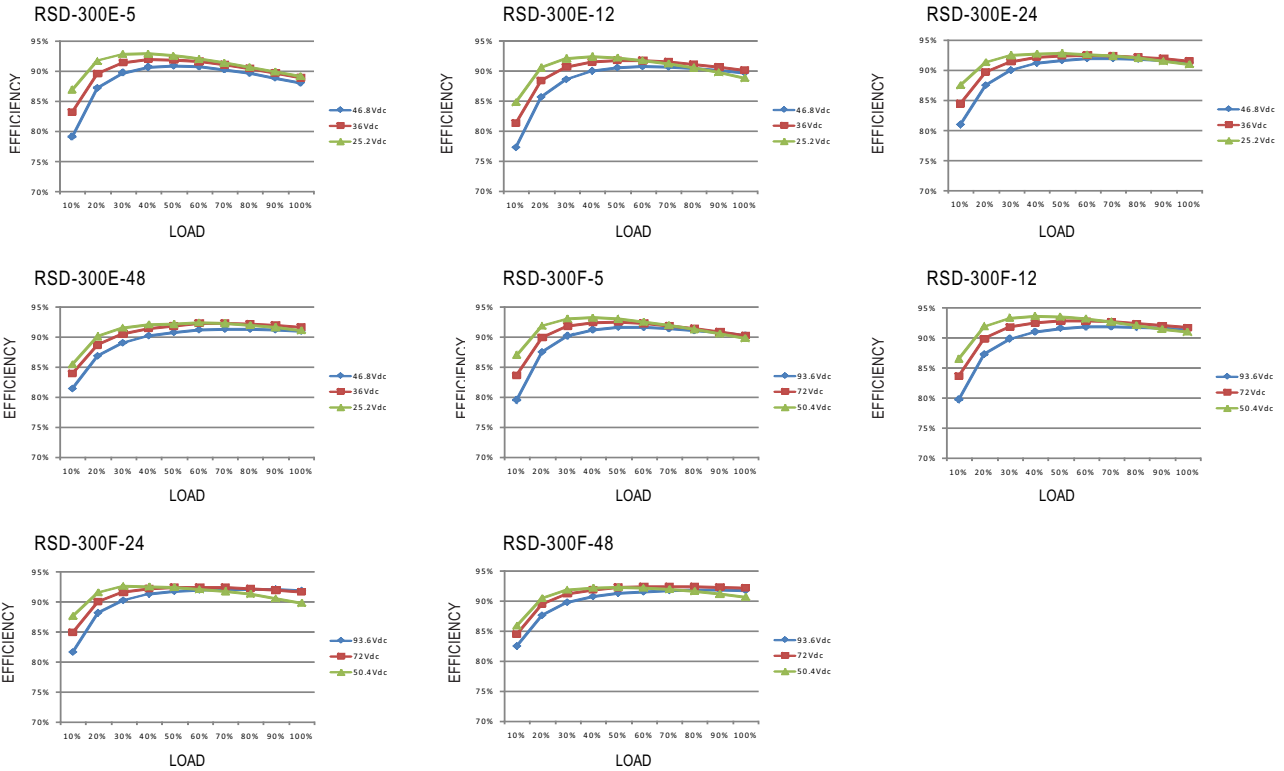

## Parallel and Series Connection

### A. Operation in Parallel

Since RSD-300 series don't have built-in parallel circuit, it can only use external circuits to achieve the redundant operation but not increase the current rating.

1. Add a diode at the positive-output of each power supply (as shown as below), the current rating of the diode should be larger than the maximum output current rating and attached to a suitable heat sink. This is only for redundant use (increase the reliability of the system) and users have to check suitability of the circuit by themselves.

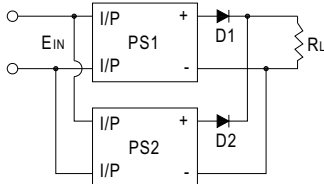

2. When using S.P.S. in parallel connection, the leakage current will increase at the same time. This could pose as a shock hazard for the user. So please contact the supplier if you have this kind of application.

### B. Operation in Series

RSD-300 can be operated in series. Here are the methods of doing it:

1. Positive and negative terminals are connected as shown as below. According to the connection, you can get the positive and negative output voltages for your loads.

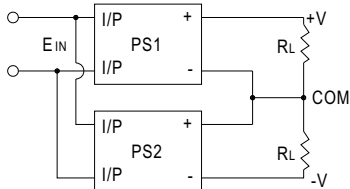

2. Increase the output voltage (current does not change). Because RSD-300 series have no reverse blocking diode in the unit, you should add an external blocking diode to prevent the damage of every unit while starting up. The voltage rating of the external diode should be larger than  $V1+V2$  (as shown as below).

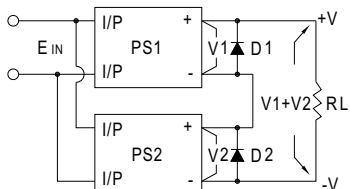

**Overload Protection**

If the output draw up to 105~135% of its output power rating, the converter will go into overload protection which is constant current mode. After the faulty condition is removed, it will recover automatically. Please refer to the diagram below for the detail operation characteristic. Please note that it's not suitable to operate within the overload region continuously, or it may cause to over temperature and reduce the life of the power supply unit or even damage it.

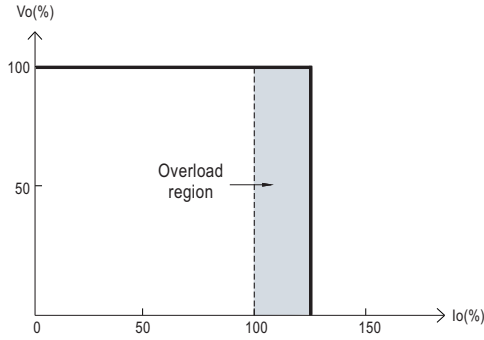

**Over Voltage Protection**

The converter shuts off to protect itself when the output voltage drawn exceeds 115~140% of its output rating. It must be repowered on to recover.

**Over Temperature Protection**

The converter shuts off to protect itself when the built-in temperature sensor mounted on the main power transformer senses a high temperature. The output recovers automatically if the temperature drops below the limit.

**LED Indicator**

Equipped with a built-in LED indicator, the converter provides an easy way for users to check its condition through the LED indicator.  
Green : normal operation; No signal: no power or failure.

**Derating Curve**

**a. Single unit operation**

If the unit has no iron plate mounted on its bottom, the maximum ambient temperature for the unit will be  $55^{\circ}\text{C}$  as operating under full load condition. It requires de-rating output current when ambient temperature is between  $55\text{--}70^{\circ}\text{C}$ , please refer to the de-rating curve as below.

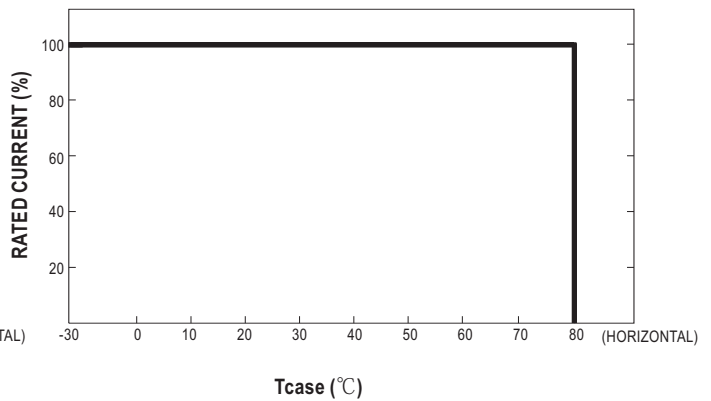
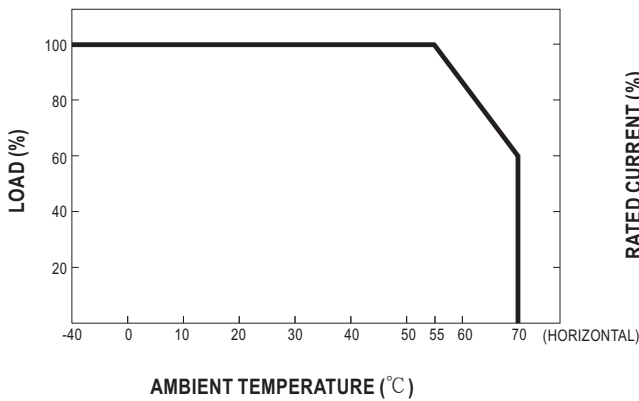



Suitable installation methods are shown as below. Since RSD-300 is a semi-potted model, its thermal performances for the following installation methods are similar and share the same derating curve.

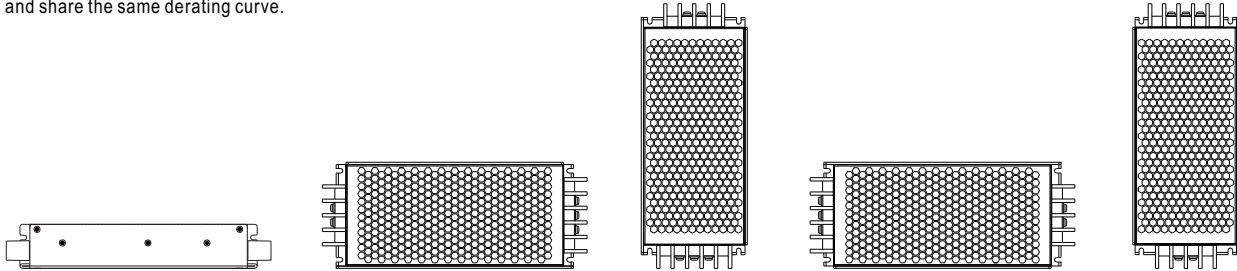

**b. Operate with additional iron plate**

If it is necessary to fulfil the requirements of EN50155 TX level that operate the unit fully-loaded at 70°C, RSD-300 series must be installed onto an iron plate on the bottom. The size of the suggested iron plate is shown as below. In order for optimal thermal performance, the iron plate must have an even & smooth surface and RSD-300 series must be firmly mounted at the center of the iron plate.

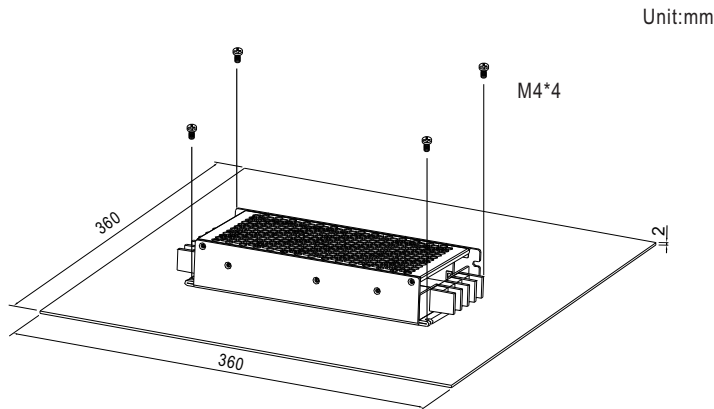

The load vs ambient temperature curve is shown as below.

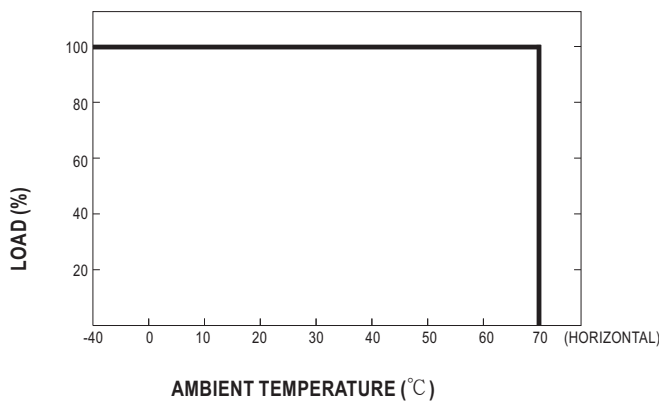

Suitable installation methods are shown as below. Since RSD-300 is a semi-potted model, its thermal performances for the following installation methods are similar and share the same derating curve.

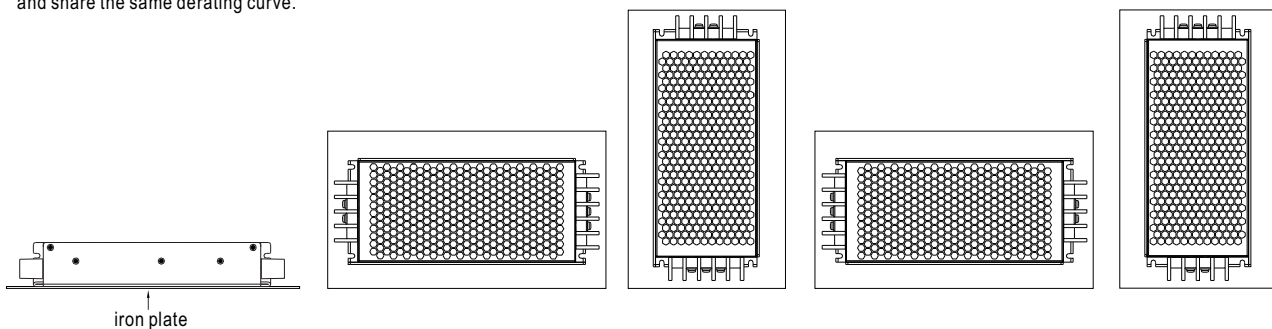



**Immunity to Environmental Conditions**

Test method	Standard	Test conditions	Status
Cooling Test	EN 50155 section 12.2.3 (Column 2, Class TX) EN 60068-2-1	Temperature: -40°C Dwell Time: 2 hrs/cycle	No damage
Dry Heat Test	EN 50155 section 12.2.4 (Column 2, Class TX) EN 50155 section 12.2.4 (Column 3, Class TX & Column 4, Class TX) EN 60068-2-2	Temperature: 70°C / 85°C Duration: 6 hrs / 10min	PASS
Damp Heat Test, Cyclic	EN 50155 section 12.2.5 EN 60068-2-30	Temperature: 25°C~55°C Humidity: 90%~100% RH Duration: 48 hrs	PASS
Vibration Test	EN 50155 section 12.2.11 EN 61373	Temperature: 19°C Humidity: 65% Duration: 10 mins	PASS
Increased Vibration Test	EN 50155 section 12.2.11 EN 61373	Temperature: 19°C Humidity: 65% Duration: 5 hrs	PASS
Shock Test	EN 50155 section 12.2.11 EN 61373	Temperature: 21 ± 3°C Humidity: 65 ± 5% Duration: 30ms*18	PASS
Low Temperature Storage Test	EN 50155 section 12.2.3 (Column 2, Class TX) EN 60068-2-1	Temperature: -40°C Dwell Time: 16 hrs	PASS
Salt Mist Test	EN 50155 section 12.2.10 (Class ST4)	Temperature: 35°C ± 2°C Duration: 96 hrs	PASS

**EN45545-2 Fire Test Conditions**

Test Items			Hazard Level		
	Items	Standard	HL1	HL2	HL3
R22	Oxygen index test	EN 45545-2:2013 EN ISO 4589-2:1996	PASS	PASS	PASS
	Smoke density test	EN 45545-2:2013 EN ISO 5659-2:2006	PASS	PASS	PASS
	Smoke toxicity test	EN 45545-2:2013 NF X70-100:2006	PASS	PASS	PASS
R24	Oxygen index test	EN 45545-2:2013 EN ISO 4589-2:1996	PASS	PASS	PASS
R25	Glow-wire test	EN 45545-2:2013 EN 60695-2-11:2000	PASS	PASS	PASS
R26	Vertical flame test	EN 45545-2:2013 EN 60695-11:2003	PASS	PASS	PASS