



# CQB100W-110S CMFC(D) SERIES 100 WATT 4:1 INPUT ISOLATED DC-DC CONVERTERS

## Features

- Efficiency Up to 91%
- Fixed Switching Frequency
- Regulated Outputs
- Remote On/Off
- Low No Load Power Consumption
- Fully Protected (OTP/OCP/OVP/UVLO)
- 3000Vdc I/O Isolation
- Operating Case Temperature -40 to +100°C
- UL 60950-1 2<sup>nd</sup> (Basic Insulation) Approval for DC Modules
- EN 50155 for EMC, Environmental and Characteristic
- Shock & Vibration (EN 61373) Compliant
- Fire & Smoke EN 45545-2 Compliant
- Safety Meets IEC/EN/UL 62368-1
- Build-In EMI Filter
- Chassis Mount, Baseplate Cooled



MODEL NUMBER	INPUT VOLTAGE	OUTPUT VOLTAGE	OUTPUT CURRENT		INPUT CURRENT		% EFF.	CAPACITOR LOAD MAX.
			MIN.	MAX.	NO LOAD	FULL LOAD		
CQB100W-110S05□-CMFC CQB100W-110S05□-CMFD	43-160 VDC	5 VDC	0 mA	20 A	15 mA	1030 mA	89	20000uF
CQB100W-110S12□-CMFC CQB100W-110S12□-CMFD	43-160 VDC	12 VDC	0 mA	8.4 A	15 mA	1010 mA	91	8400uF
CQB100W-110S15□-CMFC CQB100W-110S15□-CMFD	43-160 VDC	15 VDC	0 mA	6.7 A	15 mA	1010 mA	91	6700uF
CQB100W-110S24□-CMFC CQB100W-110S24□-CMFD	43-160 VDC	24 VDC	0 mA	4.2 A	15 mA	1040 mA	88	4200μF
CQB100W-110S28□-CMFC CQB100W-110S28□-CMFD	43-160 VDC	28 VDC	0 mA	3.6 A	15 mA	1040 mA	88	3600μF
CQB100W-110S48□-CMFC CQB100W-110S48□-CMFD	43-160 VDC	48 VDC	0 mA	2.1 A	15 mA	1020 mA	89.5	1000μF

NOTE:

1. Nominal Input Voltage 110 VDC
2. □ = N or none
3. VR1 is Used for Output Voltage Adjustment.
4. Refer to Application Note for Thermal Resistance and Derating Information.
5. TVS is Included for Input Surge Voltage Protection.
6. Recommend an External Fuse for Input Reverse Polarity Protection (Shunt Diode is Included Inside).
7. Output connector CN3 wafer with TAIWAN KING PIN TERMINAL P110I series and mate with JST housing PH series or equivalent.
8. CN1&CN2 connector: DINKLE EK500V-04P series or equivalent, suitable electric wire 24~12AWG (IEC 0.5~2.5mm<sup>2</sup>)

## PART NUMBER

Series	Nominal Input Voltage	Number of Outputs	Nominal Output Voltage	Remote On/Off Logic	Chassis Mount Type		Heatsink
CQB100W-	II	O	XX	L	-YYY	Z	+WW
CQB100W	110 : 110VDC	S : Single	05 : 5VDC 12 : 12VDC 15 : 15VDC 24 : 24VDC 28 : 28VDC 48 : 48VDC	None : Positive N : Negative	Chassis CMF : Mount Built in Filter	C : Open Frame D : With Cover	None : Blank HS : Heatsink HD : Heatsink+ Din Rail

Part Number Example:

**CQB100W-110S12N-CMFC:** Chassis Mount, 100W, 4:1 43-160Vdc Input, Single 12Vdc Output, Negative Logic, Open Frame



# CQB100W-110S CMFC(D) Series

## TECHNICAL SPECIFICATIONS

(All specifications are typical at nominal input, full load at 25°C unless otherwise noted.)

### ABSOLUTE MAXIMUM RATINGS

PARAMETER	NOTES and CONDITIONS	Device	Min.	Typ.	Max.	Units
Input Voltage	Continuous	All	-0.3		160	V <sub>dc</sub>
Input Surge Voltage	100ms max.	All			200	V <sub>dc</sub>
Operating Case Temperature	At the center part of base plate	All	-40		100	°C
Storage Temperature		All	-40		105	°C

### INPUT CHARACTERISTICS

PARAMETER	NOTES and CONDITIONS	Device	Min.	Typ.	Max.	Units
Operating Input Voltage		All	43	110	160	V <sub>dc</sub>
Input Under Voltage Lockout						
Turn-On Voltage Threshold	Full load	All	40.5	41.5	42.5	V <sub>dc</sub>
Turn-Off Voltage Threshold	Full load	All	37.5	38.5	39.5	V <sub>dc</sub>
Lockout Hysteresis Voltage	Full load	All		3		V <sub>dc</sub>
Maximum Input Current	V <sub>in</sub> =43V, Full load	All		2.6		A
No-Load Input Current	V <sub>in</sub> =110V, I <sub>o</sub> =0A	See Model Number Table				mA

### OUTPUT CHARACTERISTICS

PARAMETER	NOTES and CONDITIONS	Device	Min.	Typ.	Max.	Units
Voltage Set Point Accuracy	V <sub>in</sub> =110V, Full load, T <sub>c</sub> =25°C	All	-1.0		+1.0	%
Output Voltage Regulation						
Load Regulation	Full load to no load	05Vo Others			±0.5 ±0.2	%
Line Regulation	V <sub>in</sub> =High line to low line, full load	All			±0.2	%
Temperature Coefficient	T <sub>c</sub> =-40°C to 105°C	All			±0.02	%/°C
Output Voltage Ripple and Noise (5Hz to 20MHz Bandwidth)						
Peak-to-Peak	Full load, 1uF ceramic capacitors	5Vo			100	mV
		12Vo			100	
		15Vo			100	
		24Vo			200	
		28Vo			200	
		48Vo			300	
RMS.		05Vo			40	mV
		12Vo			40	
		15Vo			40	
		24Vo			100	
		28Vo			100	
		48Vo			150	
Output Current Range	V <sub>in</sub> = 43 to 160V	See Model Number Table				A
Over Current Protection	Hiccup mode. Auto recovery	All	110	125	160	%
Short Circuit Protection		All	Continuous, Auto Recovery			
External Load Capacitance	Full load (resistive)	See Model Number Table				uF
Output Voltage Trim Range	P <sub>o</sub> ≤ max. rated power, I <sub>o</sub> ≤ I <sub>o,max</sub> .	15Vo Others	-20 -10		+10 +10	%
Output Voltage Remote Sense Range	P <sub>o</sub> ≤ max. rated power, I <sub>o</sub> ≤ I <sub>o,max</sub> . % of nominal V <sub>o</sub>	All			+10	%
Over Voltage Protection	Limited voltage, % of nominal V <sub>o</sub>	All	115	125	140	%



# CQB100W-110S CMFC(D) Series

## EFFICIENCY

PARAMETER	NOTES and CONDITIONS	Device	Min.	Typ.	Max.	Units
100% Load	$V_{in}=110V$	See Model Number Table				%

## DYNAMIC CHARACTERISTICS

PARAMETER	NOTES and CONDITIONS	Device	Min.	Typ.	Max.	Units
Output Voltage Current Transient						
Error Band	75% to 100% of $I_{o\_max}$ . Step load change $di/dt=0.1A/\mu s$ (within 1% $V_{out}$ nominal)	All			±5	%
Recovery Time		All			250	us
Turn-On Delay and Rise Time						
Full load (Constant resistive load)						
Turn-On Delay Time, From On/Off Control	$V_{on/off}$ to 10% $V_{o\_set}$ , Remote on	All		50		ms
Turn-On Delay Time, From Input	$V_{in\_min.}$ to 10% $V_{o\_set}$ , Power up	All		50		ms
Output Voltage Rise Time	10% $V_{o\_set}$ to 90% $V_{o\_set}$	All		50		ms

## ISOLATION CHARACTERISTICS

PARAMETER	NOTES and CONDITIONS	Device	Min.	Typ.	Max.	Units
Isolation Voltage (100% factory Hi-Pot tested @2sec.)	1 Minute; input to output	All			3000	$V_{dc}$
	1 Minute; input to case (base plate)				2250	$V_{dc}$
	1 Minute; output to case (base plate)				500	$V_{ac}$
Isolation Resistance	Input to output	All	100			MΩ
Isolation Capacitance	Input to output	05Vo		1500		pF
		12Vo		1500		
		15Vo		1500		
		24Vo		1500		
		28Vo		1500		
		48Vo		1500		
	Input to case (base plate)	05Vo		4600		
		12Vo		7680		
		15Vo		4580		
		24Vo		4800		
		28Vo		6040		
		48Vo		5820		
	Output to Case (base plate)	05Vo		2670		
		12Vo		15500		
		15Vo		19400		
		24Vo		6700		
		28Vo		6200		
		48Vo		10200		

## FEATURE CHARACTERISTICS

PARAMETER	NOTES and CONDITIONS	Device	Min.	Typ.	Max.	Units
Switching Frequency	Pulse width modulation (PWM), fixed	All	270	300	330	KHz
On/Off Control, Positive Remote On/Off Logic, Refer to -Vin Pin						
Logic Low (Module Off)	$V_{on/off}$ at $I_{on/off}=0.0\mu A$ , Pin open=off	All	0		1.2	V
Logic High (Module On)	$V_{on/off}$ at $I_{on/off}=1.0mA$	All	3.5 or Open Circuit		160	V



# CQB100W-110S CMFC(D) Series

PARAMETER	NOTES and CONDITIONS	Device	Min.	Typ.	Max.	Units
On/Off Control, Negative Remote On/Off Logic, Refer to -Vin Pin						
Logic High (Module Off)	$V_{on/off}$ at $I_{on/off}=1.0mA$	All	3.5 or Open Circuit		160	V
Logic Low (Module On)	$V_{on/off}$ at $I_{on/off}=0.0uA$ , Pin open=on	All	0		1.2	V
On/Off Current (for Both Remote On/Off Logic)	$I_{on/off}$ at $V_{on/off}=0.0V$	All		0.3	1	mA
Off Converter Input Current	Shutdown input idle current	All		5	10	mA
Over Temperature Shutdown	Temperature at the center part of base plate, non-latching (DC module)	All		105		°C
Over Temperature Recovery		All		100		°C

## GENERAL SPECIFICATIONS

PARAMETER	NOTES and CONDITIONS	Device	Min.	Typ.	Max.	Units
MTBF	$I_o=100\%$ of $I_{o\_max.}$ ; MIL-HDBK - 217F_Notice 1, GB, 25°C	05Vo		514		K hours
		12Vo		552		
		15Vo		611		
		24Vo		728		
		28Vo		618		
		48Vo		750		
Weight		-CMFC		222		grams
		-CMFD		246		
		-CMFD+HS		487		
		-CMFD+HD		504		
Base plate Material	Aluminum					
Potting Material	UL 94V-0 (DC Module)					
Shock/Vibration	EN 50155 (EN 61373) Compliant					
Humidity	95% RH max. Non condensing					
Altitude	3000m Operating altitude, 12000m Transport altitude					
Thermal Shock	MIL-STD-810F					
Fire & Smoke	EN 45545-2 Compliant					
EMI	EN 50155 Compliant (external filter required for EN 50121-3-2)					Class A
ESD	EN 61000-4-2 Level 3: Air $\pm 8kV$ , Contact $\pm 6kV$					Perf. Criteria A
Radiated Immunity	EN 61000-4-3 Level 3: 80~1000MHz, 20V/m					Perf. Criteria A
Fast Transient	EN 61000-4-4 Level 3: On power input port, $\pm 2kV$					Perf. Criteria A
Surge	EN 61000-4-5 Level 4: Line to earth, $\pm 4kV$ , Line to line, $\pm 2kV$					Perf. Criteria A
Conducted Immunity	EN 61000-4-6 Level 3: 0.15~80MHz, 10V					Perf. Criteria A
Interruptions of Voltage Supply	EN 50155 Class S2: 10ms interruptions, with external hold up circuit and capacitor required					Perf. Criteria A
Supply Change Over	EN 50155 Class C2: During a supply break of 30ms, with external hold up circuit and capacitor required					Perf. Criteria B
Application Note Link	<a href="#">CQB100W-110S CMFC(D) Series App Notes</a>					
Packaging Information Link	<a href="#">Packaging Information</a>					



# CQB100W-110S CMFC(D) Series

## Immunity to Environmental Conditions.

Phenomenon	Reference Clause(s)	Reference Standard	Test Conditions	Result
Low Temperature Start-up test	13.4.4	EN 60068-2-1	Class OT6 Temperature: -40°C Duration: 2 hrs	Pass
Dry Heat Test	13.4.5	EN 60068-2-2	Class OT6 & ST0 Temperature: 85°C Duration: 6 hrs	Pass
Low Temperature Storage Test	13.4.6	EN 60068-2-1	Temperature: -40°C Duration: 16 hrs	Pass
Cyclic Damp Heat Test	13.4.7	EN 60068-2-30	Temperature: 25°C - 55°C Humidity: 90% RH Duration: 48 hrs	Pass
Random Vibration Test	13.4.11	EN 61373	Temperature: 25°C±10°C Humidity: 50% ±25% RH Frequency range: 5 ~ 150 Hz Vertical: 1.01 $m/s^2$ Transverse: 0.450 $m/s^2$ Longitudinal: 0.700 $m/s^2$ Duration: 10 min / axis	Pass
Simulated Long Life Test at Increased Random Vibration Levels	13.4.11	EN 61373	Temperature: 25°C±10°C Humidity: 50% ±25% RH Frequency range: 5 ~ 150 Hz Vertical: 5.72 $m/s^2$ Transverse: 2.55 $m/s^2$ Longitudinal: 3.96 $m/s^2$ Duration: 5 hrs / axis	Pass
Shock Test	13.4.11	EN 61373	Temperature: 25°C±10°C Humidity: 50% ±25% RH Frequency range: 5 ~ 150 Hz ±Vertical: 30 $m/s^2$ ±Transverse: 30 $m/s^2$ ±Longitudinal: 50 $m/s^2$ Duration: 30ms x18 (Each axis 3 shocks)	Pass

## EN 45545-2 Fire & Smoke Test Conditions.

Item		Standard	Hazard Level
R22	Oxygen Index Test	EN 45545-2: 2013 EN ISO 4589-2: 2006	HL1, HL2, HL3
	Smoke Density Test	EN 45545-2: 2013 EN ISO 5659-2: 2013	HL1, HL2, HL3
	Smoke Toxicity Test	EN 45545-2: 2013 NF X70-100: 2006	HL1, HL2, HL3
R23	Oxygen Index Test	EN 45545-2: 2013 EN ISO 4589-2: 2006	HL1, HL2, HL3
	Smoke Density Test	EN 45545-2: 2013 EN ISO 5659-2: 2013	HL1, HL2, HL3
	Smoke Toxicity Test	EN 45545-2: 2013 NF X70-100: 2006	HL1, HL2, HL3
R24	Oxygen Index Test	EN 45545-2: 2013 EN ISO 4589-2	HL1, HL2, HL3
R25	Glow - Wire Test	EN 45545-2:2013 EN 60695-2-11:2001	HL1, HL2, HL3
R26	Vertical Flame Test	EN 45545-2: 2013 EN 60695-11-10: 2013	HL1, HL2, HL3



# CQB100W-110S CMFC(D) Series

## CHARACTERISTIC CURVE

### Power Derating Curve

CQB100W-110S CMFC(D) Derating Curve with Heat Sink FBL254 (Vin=110V)

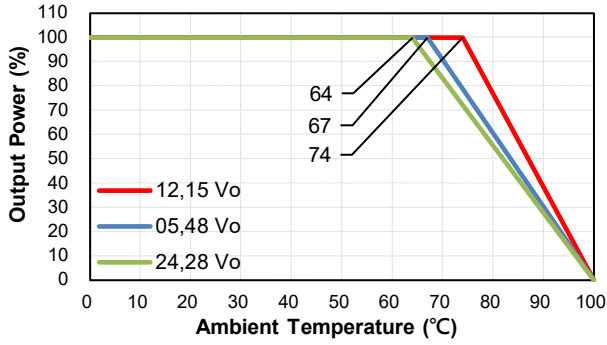

CQB100W-110S CMFC+HS(HD) Derating Curve (Vin=110V)

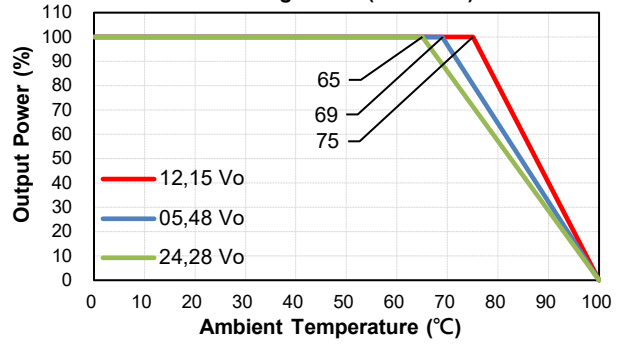

CQB100W-110S CMFC(D) Derating Curve with Iron Plate 17x17x0.04 inch (Vin=110V)

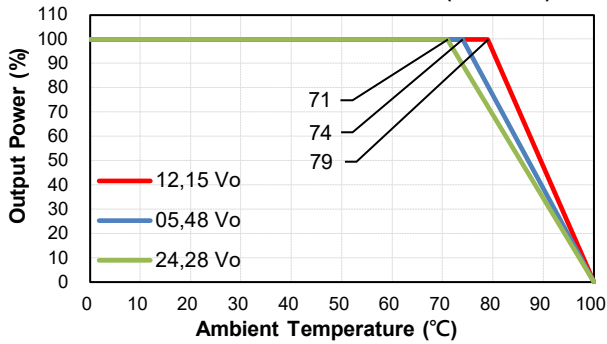

### Performance Data

CQB100W-110S05-CMFC Eff Vs Io @25 Deg. C

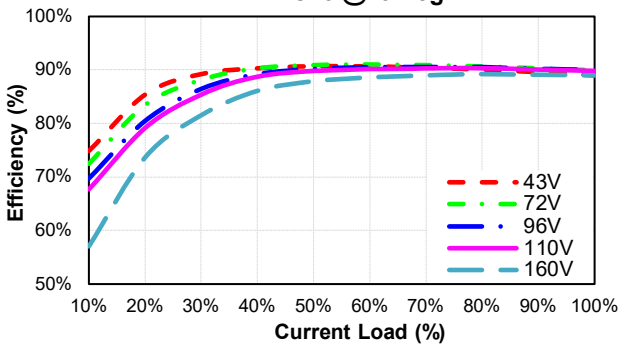

CQB100W-110S05-CMFC Pd Vs Po @25 Deg. C

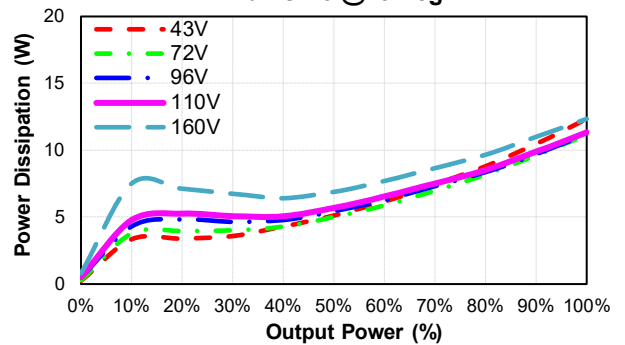



# CQB100W-110S CMFC(D) Series

**CQB100W-110S12-CMFC**  
Eff Vs Io @25 Deg. C

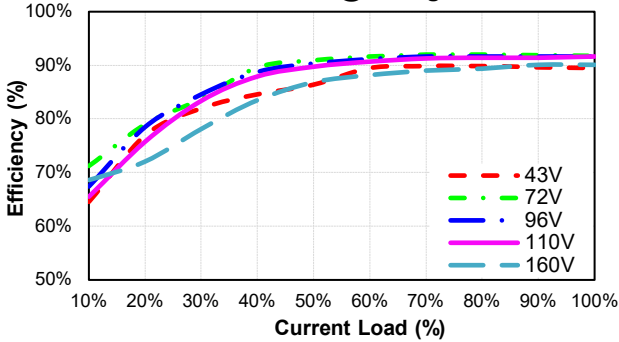

**CQB100W-110S12-CMFC**  
Pd Vs Po @25 Deg. C

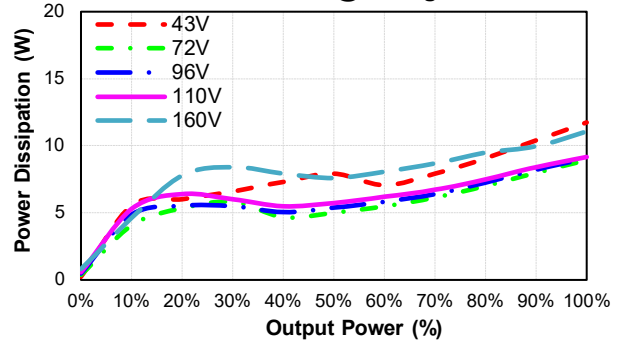

**CQB100W-110S15-CMFC**  
Eff Vs Io @25 Deg. C

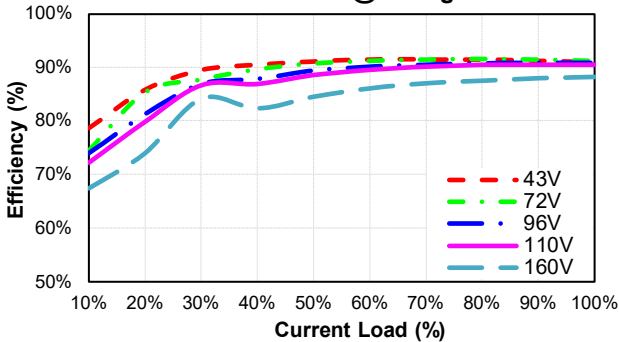

**CQB100W-110S15-CMFC**  
Pd Vs Po @25 Deg. C

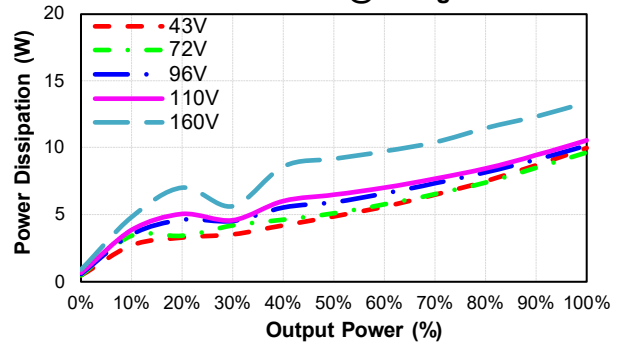

**CQB100W-110S24-CMFC**  
Eff Vs Io @25 Deg. C

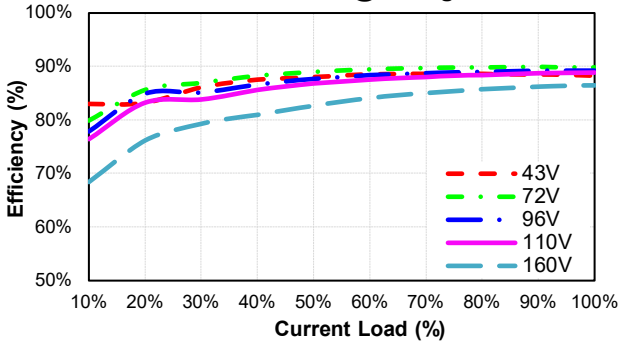

**CQB100W-110S24-CMFC**  
Pd Vs Po @25 Deg. C

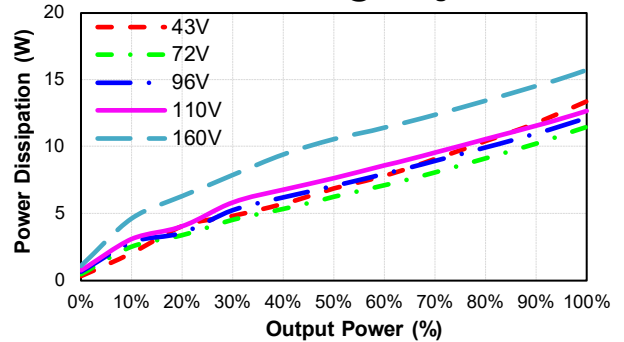

**CQB100W-110S28-CMFC**  
Eff Vs Io @25 Deg. C

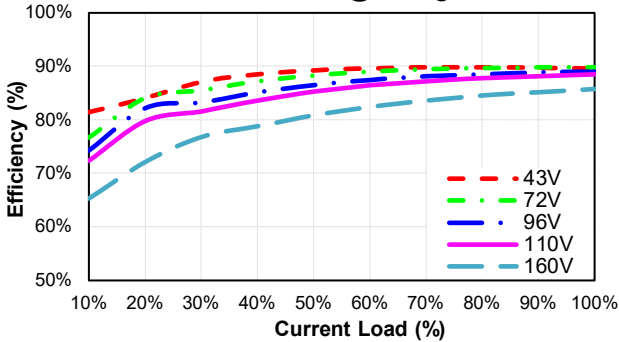

**CQB100W-110S28-CMFC**  
Pd Vs Po @25 Deg. C

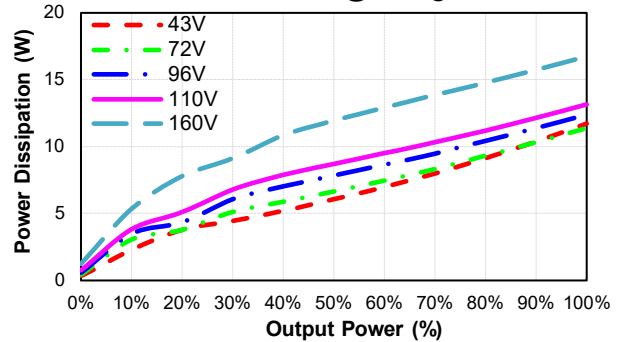



# CQB100W-110S CMFC(D) Series

CQB100W-110S48-CMFC  
Eff Vs Io @25 Deg. C

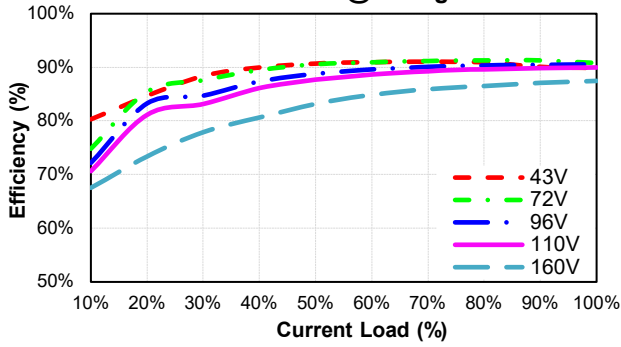

CQB100W-110S48-CMFC  
Pd Vs Po @25 Deg. C

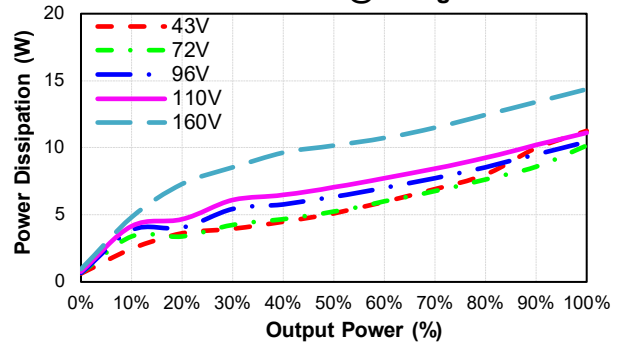





# CQB100W-110S CMFC(D) Series

## MECHANICAL SPECIFICATION

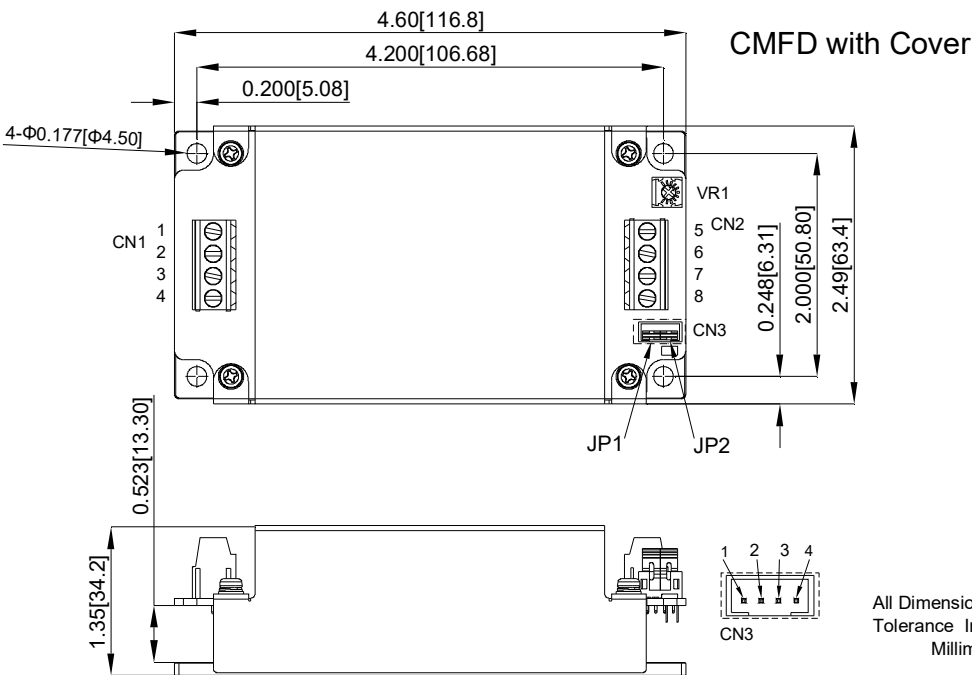
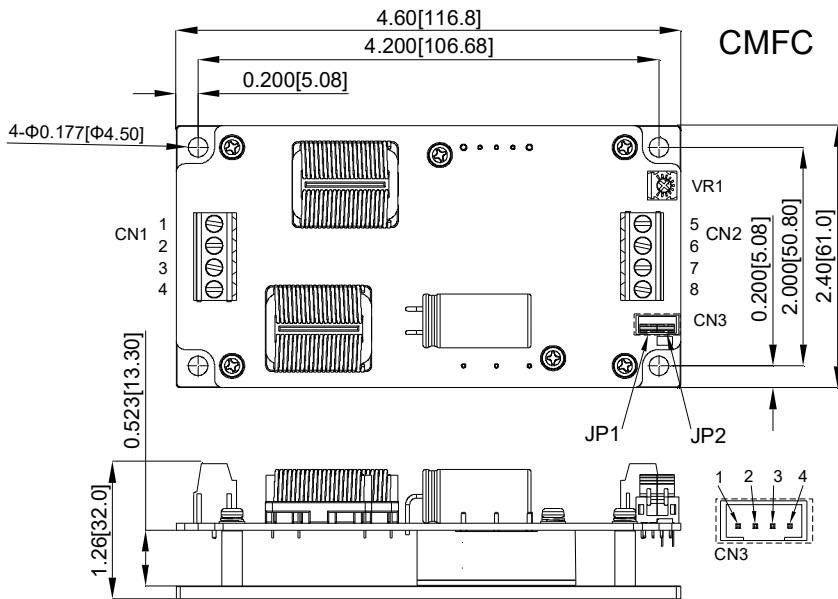

CN1&CN2  
PIN CONNECTION

PIN	Function
1	+V Input
2	-V Input
3	Remote
4	Case
5	+V Output
6	+V Output
7	-V Output
8	-V Output

CN3  
PIN CONNECTION

PIN	Function
1	-V Output
2	-Sense
3	+Sense
4	+V Output

\*JP1: Short PIN1 & PIN2  
\*JP2: Short PIN3 & PIN4

All Dimensions In Inches (mm)  
Tolerance Inches: X.XX=±0.02, X.XXX=±0.010  
Millimeters: X.X=±0.5, X.XX=±0.25



# CQB100W-110S CMFC(D) Series

## MECHANICAL SPECIFICATION

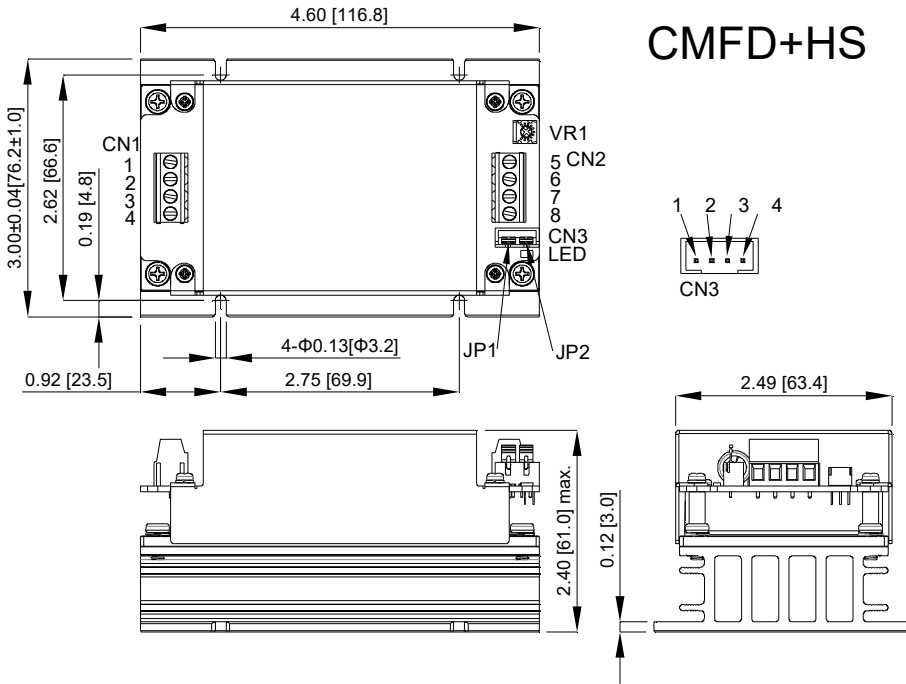

### CMFD+HS

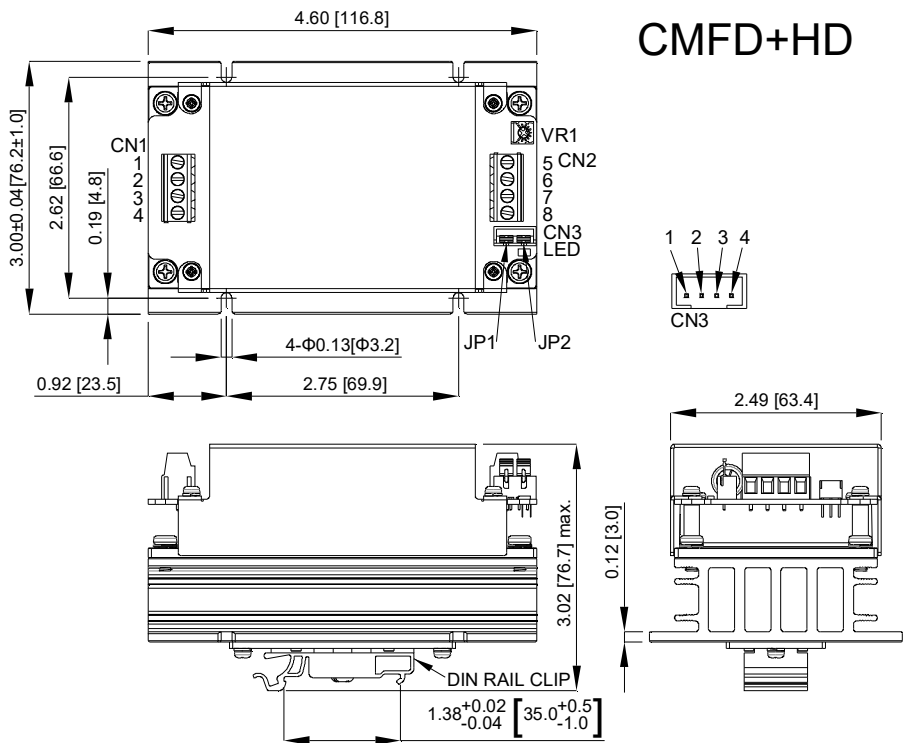
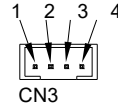

### CMFD+HD

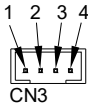

#### CN1 & CN2 PIN CONNECTION

PIN	Function
1	+V Input
2	-V Input
3	Remote
4	Case
5	+V Output
6	+V Output
7	-V Output
8	-V Output

#### CN3 PIN CONNECTION

PIN	Function
1	-V Output
2	-Sense
3	+Sense
4	+V Output

\*JP1: Short PIN1 & PIN2  
\*JP2: Short PIN3 & PIN4

All Dimensions in Inches[mm]  
Tolerance Inches: x.xx±0.02, x.xxx±0.010  
Millimeters: x.x±0.5, x.xx±0.25