



electronicpowersolutions

CQB50W12 CMFC(D) SERIES 30-50 WATT 12:1 INPUT ISOLATED DC-DC CONVERTERS

Features

- Efficiency Up to 89%
- Fixed Switching Frequency
- Regulated Outputs
- Remote On/Off
- Low No Load Power Consumption
- Fully Protected (OTP/OCP/OVP/UVLO)
- 3000Vdc I/O Isolation
- Operating Case Temperature -40 to +100°C
- UL 60950-1 2nd (Basic Insulation) Approval for DC Modules
- EN 50155 for EMC, Environmental and Characteristic
- Shock & Vibration EN 50155 (EN 61373) Compliant
- Fire & Smoke EN 45545-2 Compliant
- Safety Meets IEC/EN/UL 62368-1
- Build-In EMI Filter
- Chassis Mount, Baseplate Cooled



MODEL NUMBER	INPUT VOLTAGE	OUTPUT VOLTAGE	OUTPUT CURRENT		INPUT CURRENT		% EFF.	CAPACITOR LOAD MAX.
			MIN.	MAX.	NO LOAD	FULL LOAD		
CQB50W12-72S05□-CMFC CQB50W12-72S05□-CMFD	14-160 VDC	5 VDC	0 mA	6.0 A	8 mA	530 mA	83	10000uF
CQB50W12-72S12□-CMFC CQB50W12-72S12□-CMFD	14-160 VDC	12 VDC	0 mA	4.2 A	8 mA	810 mA	87	6800uF
CQB50W12-72S24□-CMFC CQB50W12-72S24□-CMFD	14-160 VDC	24 VDC	0 mA	2.1 A	8 mA	810 mA	89	3300µF
CQB50W12-72S48□-CMFC CQB50W12-72S48□-CMFD	14-160 VDC	48 VDC	0 mA	1.05 A	12 mA	810 mA	88	680µF

NOTE:

1. Nominal Input Voltage 72 VDC, Input Voltage Range: 14-16.8 VDC (t ≤ 60 sec.)
2. □ = N or none
3. VR1 is Used for Output Voltage Adjustment.
4. Refer to Application Note for Thermal Resistance and Derating Information.
5. TVS is Included for Input Surge Voltage Protection.
6. Recommend an External Fuse for Input Reverse Polarity Protection (shunt diode is included inside).
7. Output connector CN3 wafer with TAIWAN KING PIN TERMINAL P110I series and mate with JST housing PH series or equivalent.
8. CN1 & CN2 connection: DINKLE EK500V-04P series or equivalent, suitable electric wire: 24~12AWG (IEC 0.5~2.5mm²).

PART NUMBER

Series	Nominal Input Voltage	Number of Outputs	Nominal Output Voltage	Remote On/Off Logic	Chassis Mount Type		Heatsink
CQB50W12-	II	O	XX	L	-YYY	Z	+WW
CQB50W12	72 : 72 VDC	S : Single	05 : 5VDC 12 : 12VDC 24 : 24VDC 48 : 48VDC	None : Positive N : Negative	CMF : Chassis Mount Built in Filter	C : Open Frame D : With Cover	None : Blank HS : Heatsink HD : Heatsink+ Din Rail

Part Number Example:

CQB50W12-72S12N-CMFC: Chassis Mount, 50W, 12:1 14-160Vdc Input, Single 12Vdc Output, Negative Logic, Open Frame



CQB50W12 CMFC(D) Series

TECHNICAL SPECIFICATIONS

(All specifications are typical at nominal input, full load at 25°C unless otherwise noted.)

ABSOLUTE MAXIMUM RATINGS

PARAMETER	NOTES and CONDITIONS	Device	Min.	Typ.	Max.	Units
Input Voltage	Continuous	All	-0.3		160	V _{dc}
Input Surge Voltage	100ms max.	All			200	V _{dc}
Operating Case Temperature	At the center part of base plate	All	-40		100	°C
Storage Temperature		All	-40		105	°C

INPUT CHARACTERISTICS

PARAMETER	NOTES and CONDITIONS	Device	Min.	Typ.	Max.	Units
Operating Input Voltage		All	14	72	160	V _{dc}
Input Under Voltage Lockout						
Turn-On Voltage Threshold	Full load	All	14.2	14.6	15	V _{dc}
Turn-Off Voltage Threshold	Full load	All	11.6	12.6	13	V _{dc}
Lockout Hysteresis Voltage	Full load	All		2.0		V _{dc}
Maximum Input Current	V _{in} =16.8V, Full load	72S05 Other		2.3 4		A
No-Load Input Current	V _{in} =72V, I _o =0A		See Model Number Table			mA

OUTPUT CHARACTERISTICS

PARAMETER	NOTES and CONDITIONS	Device	Min.	Typ.	Max.	Units
Voltage Set Point Accuracy	V _{in} =72V, Full load, T _c =25°C	All	-1.0		+1.0	%
Output Voltage Regulation						
Load Regulation	Full load to no load	All			±0.2	%
Line Regulation	V _{in} =High line to low line, full load	All			±0.2	%
Temperature Coefficient	T _c =-40°C to 100°C	All			±0.02	%°C
Output Voltage Ripple and Noise (5Hz to 20MHz Bandwidth)						
Peak-to-Peak	Full load, 1uF ceramic capacitors	All			100	mV
RMS.					40	
Output Current Range	V _{in} = 14 to 160V		See Model Number Table			A
Over Current Protection	Hiccup mode. Auto recovery	All	110	180	220	%
Short Circuit Protection		All	Continuous, Auto Recovery.			
External Load Capacitance	Full load (resistive)		See Model Number Table			uF
Output Voltage Trim Range	P _o ≤ max. rated power, I _o ≤ I _{o,max} .	All	-20		+10	%
Output Voltage Remote Sense Range	P _o ≤ max. rated power, I _o ≤ I _{o,max} . % of nominal V _o	All			+10	%
Over Voltage Protection	Limited voltage, % of nominal V _o	All	115	125	140	%

EFFICIENCY

PARAMETER	NOTES and CONDITIONS	Device	Min.	Typ.	Max.	Units
100% Load	V _{in} =72V, 110V		See Model Number Table			%

DYNAMIC CHARACTERISTICS

PARAMETER	NOTES and CONDITIONS	Device	Min.	Typ.	Max.	Units
Output Voltage Current Transient						
Error Band	75% to 100% of I _{o,max} . step load change d/d _t =0.1A/us (within 1% V _{out} nominal)	All			±5	%
Recovery Time					250	us



CQB50W12 CMFC(D) Series

PARAMETER	NOTES and CONDITIONS	Device	Min.	Typ.	Max.	Units
Turn-On Delay and Rise Time	Full load (Constant resistive load)					
Turn-On Delay Time, From On/Off Control	$V_{on/off}$ to 10% V_{o_set} , Remote on	All		15		ms
Turn-On Delay Time, From Input	$V_{in_min.}$ to 10% V_{o_set} , Power up	All		15		ms
Output Voltage Rise Time	10% V_{o_set} to 90% V_{o_set}	All		10		ms

ISOLATION CHARACTERISTICS

PARAMETER	NOTES and CONDITIONS	Device	Min.	Typ.	Max.	Units
Isolation Voltage (100% factory Hi-Pot tested @2sec.)	1 Minute; input to output	All			3000	V_{dc}
	1 Minute; input to case (base plate)				2500	
	1 Minute; output to case (base plate)				500	V_{ac}
Isolation Resistance	Input to output	All	200			MΩ
Isolation Capacitance	Input to output	All		3000		pF
	Input to case (base plate)			5000		
	Output to case (base plate)			10000		

FEATURE CHARACTERISTICS

PARAMETER	NOTES and CONDITIONS	Device	Min.	Typ.	Max.	Units
Switching Frequency	Pulse width modulation (PWM), fixed	All	215	240	265	KHz
On/Off Control, Positive Remote On/Off Logic, Refer to -Vin Pin						
Logic Low (Module Off)	$V_{on/off}$ at $I_{on/off}=1.0mA$	All	0		1.2	V
Logic High (Module On)	$V_{on/off}$ at $I_{on/off}=0.0uA$, Pin open=on		3.5		160	
On/Off Control, Negative Remote On/Off Logic, Refer to -Vin Pin						
Logic High (Module Off)	$V_{on/off}$ at $I_{on/off}=0.0uA$, Pin open=off	All	4.0		160	V
Logic Low (Module On)	$V_{on/off}$ at $I_{on/off}=1.0mA$		0		1.2	
On/Off Current (for Both Remote On/Off Logic)	$I_{on/off}$ at $V_{on/off}=0V$	All		0.3	1	mA
Leakage Current (for Both Remote On/Off Logic)	Logic high, $V_{on/off}=15V$	All			30	uA
Off Converter Input Current	Shutdown input idle current	All		3	5	mA
Over Temperature Shutdown	Temperature at the center part of base plate, non-latching	All		110		°C
Over Temperature Recovery				100		

GENERAL SPECIFICATIONS

PARAMETER	NOTES and CONDITIONS	Device	Min.	Typ.	Max.	Units
MTBF	$I_o=100%$ of $I_{o_max.}$; MIL-HDBK - 217F_Notice 1, GB, 25°C	72S05		506		K hours
		36S12		484		
		36S24		515		
		36S48		513		
Weight		-CMFC		215		grams
		-CMFD		250		
		-CMFD+HS		470		
		-CMFD+HD		490		
Base plate Material	Aluminum					
Potting Material	UL 94V-0 (DC Module)					
Shock/Vibration	EN 50155 (EN 61373) Compliant					
Humidity	95% RH max. Non condensing					
Altitude	5000m Operating altitude, 12000m Transport altitude					
Thermal Shock	MIL-STD-810F					
Fire & Smoke	EN 45545-2 Compliant					
EMI	EN 55032 & EN 50155 (with external output filter) Compliant					Class A
ESD	EN 61000-4-2 Level 3: Air ±8kV, Contact ±6kV					Perf. Criteria A
Radiated Immunity	EN 61000-4-3 Level 3: 80~1000MHz, 20V/m					Perf. Criteria A



CQB50W12 CMFC(D) Series

Fast Transient	EN 61000-4-4	Level 3: On power input port, $\pm 2kV$	Perf. Criteria A
Surge	EN 61000-4-5	Level 4: Line to earth, $\pm 4kV$, Line to line, $\pm 2kV$	Perf. Criteria A
Conducted Immunity	EN 61000-4-6	Level 3: 0.15~80MHz, 10V	Perf. Criteria A
Interruptions of Voltage Supply	EN 50155	Class S3: 20ms interruptions	Perf. Criteria A
Supply Change Over	EN 50155	Class C2: During a supply break of 30ms	Perf. Criteria A
Application Note Link			CQB50W12-72S CMFC(D) Series App Notes
Packaging Information Link			Packaging Information

Immunity to Environmental Conditions.

Phenomenon	EN 50155; 2017 Reference Clause(s)	Reference Standard	Test Conditions	Result
Low Temperature Start-up test	13.4.4	EN 60068-2-1	Class OT4 Temperature: $-40^{\circ}C$ Duration: 2 hrs	Pass
Dry Heat Test	13.4.5	EN 60068-2-2	Class OT4 & ST2 Temperature: $70^{\circ}C$ Duration: 6 hrs Extended temperature: $85^{\circ}C$ Extended Duration: 10min	Pass
Low Temperature Storage Test	13.4.6	EN 60068-2-1	Temperature: $-40^{\circ}C$ Duration: 16 hrs	Pass
Cyclic Damp Heat Test	13.4.7	EN 60068-2-30	Temperature: $25^{\circ}C - 55^{\circ}C$ Humidity: 90 ~ 96% RH Duration: 48 hrs	Pass
Random Vibration Test	13.4.11	EN 61373	Temperature: $26^{\circ}C \pm 3^{\circ}C$ Humidity: 50% $\pm 25\%$ RH Frequency range: 5 ~ 150 Hz Vertical: $1.01 m/s^2$ Transverse: $0.450 m/s^2$ Longitudinal: $0.700 m/s^2$ Duration: 10 min / axis	Pass
Simulated Long Life Test at Increased Random Vibration Levels	13.4.11	EN 61373	Temperature: $26^{\circ}C \pm 3^{\circ}C$ Humidity: 70% $\pm 5\%$ RH Frequency range: 5 ~ 150 Hz Vertical: $5.72 m/s^2$ Transverse: $2.55 m/s^2$ Longitudinal: $3.96 m/s^2$ Duration: 5 hrs / axis	Pass
Shock Test	13.4.11	EN 61373	Temperature: $26^{\circ}C \pm 3^{\circ}C$ Humidity: 70% $\pm 5\%$ RH Frequency range: 5 ~ 150 Hz \pm Vertical: $30 m/s^2$ \pm Transverse: $30 m/s^2$ \pm Longitudinal: $50 m/s^2$ Duration: 30ms x18 (Each axis 3 shocks)	Pass

EN 45545-2 Fire & Smoke Test Conditions.

Item	Standard	Hazard Level
R22	Oxygen Index Test EN 45545-2: 2013+A1:2015 EN ISO 4589-2: 2017	HL1, HL2, HL3
	Smoke Density Test EN 45545-2: 2013+A1:2015 EN ISO 5659-2: 2017	HL1, HL2, HL3
	Smoke Toxicity Test EN 45545-2: 2013+A1:2015 NF X70-100-1 and -2: 2006	HL1, HL2, HL3
R23	Oxygen Index Test EN 45545-2: 2013+A1:2015 EN ISO 4589-2: 2017	HL1, HL2, HL3
	Smoke Density Test EN 45545-2: 2013+A1:2015 EN ISO 5659-2: 2013	HL1, HL2, HL3
	Smoke Toxicity Test EN 45545-2: 2013+A1:2015 NF X70-100-1 and -2: 2006	HL1, HL2, HL3
R24	Oxygen Index Test EN 45545-2: 2013 EN ISO 4589-2	HL1, HL2, HL3
R25	Glow - Wire Test EN 45545-2+A1:2016 EN 60695-2-11:2014	HL1, HL2, HL3
R26	Vertical Flame Test EN 45545-2: 2013 EN 60695-11-10: 2013	HL1, HL2, HL3



CQB50W12 CMFC(D) Series

CHARACTERISTIC CURVE

Power Derating Curve

CQB50W12-72S CMFC(D) Derating Curve with Heatsink Iron plate (Vin=72V)

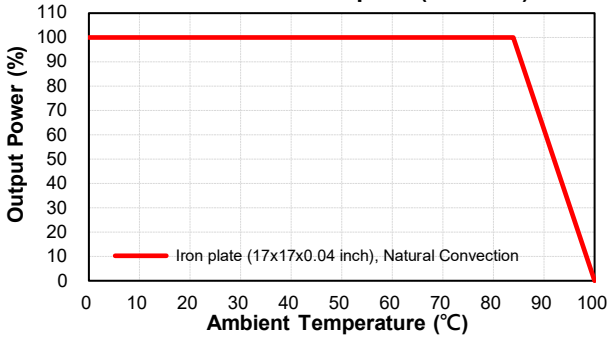

CQB50W12-72S CMFC(D) Derating Curve with Heatsink FBL254 (Vin=72V)

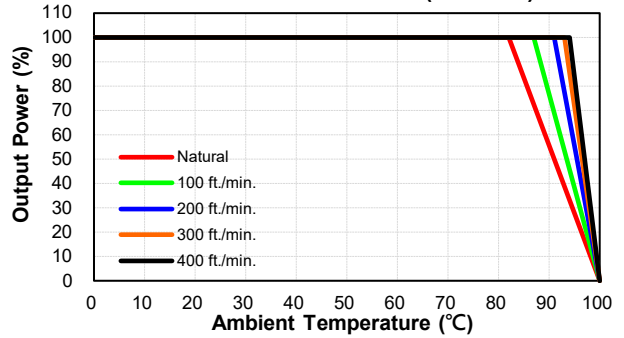

CQB50W12-72S-CMFD+HS(HD) Derating Curve (Vin=72V)

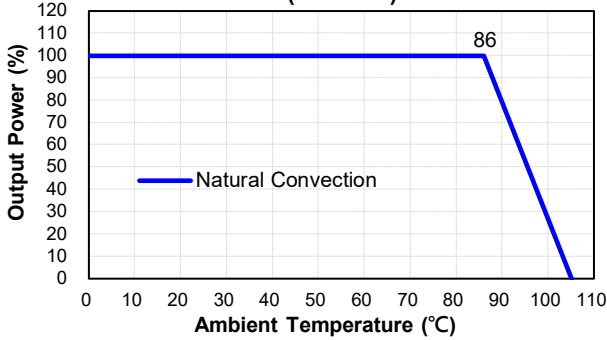

Performance Data

CQB50W12-72S05-CMFC Eff Vs Io @25 Deg. C

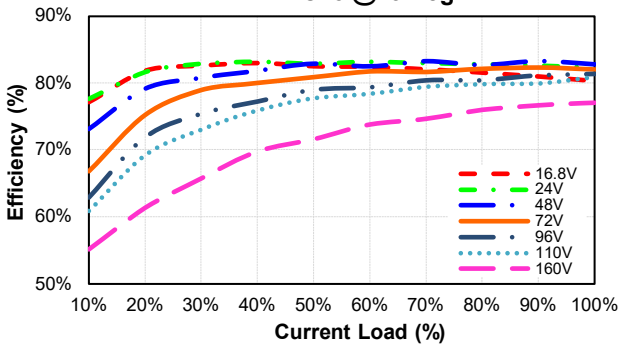

CQB50W12-72S05-CMFC Pd Vs Po @25 Deg. C

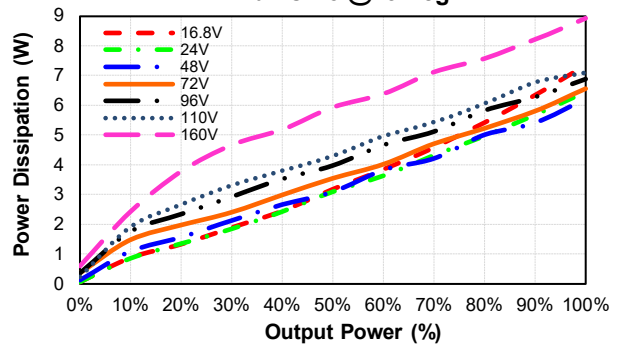



CQB50W12 CMFC(D) Series

CQB50W12-72S12-CMFC
Eff Vs Io @25 Deg. C

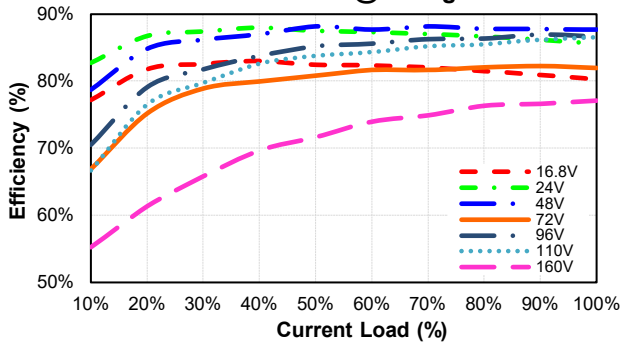

CQB50W12-72S12-CMFC
Pd Vs Po @25 Deg. C

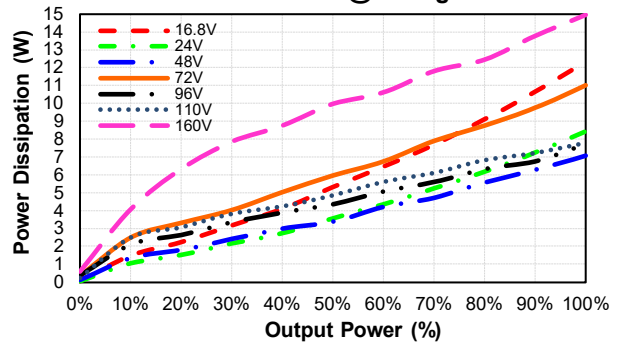

CQB50W12-72S24-CMFC
Eff Vs Io @25 Deg. C

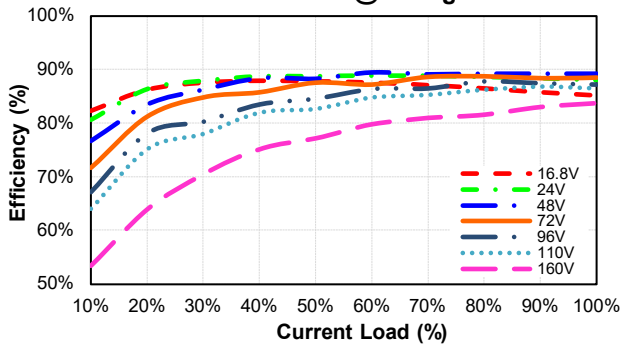

CQB50W12-72S24-CMFC
Pd Vs Po @25 Deg. C

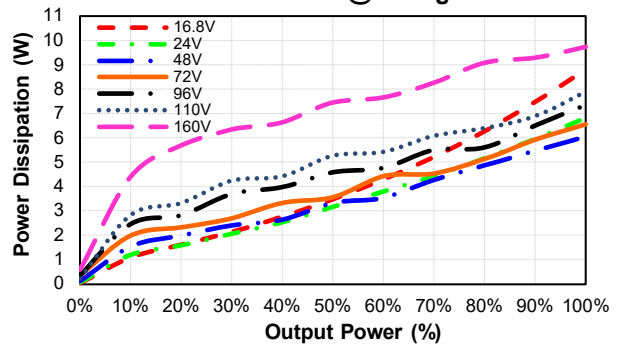

CQB50W12-72S48-CMFC
Eff Vs Io @25 Deg. C

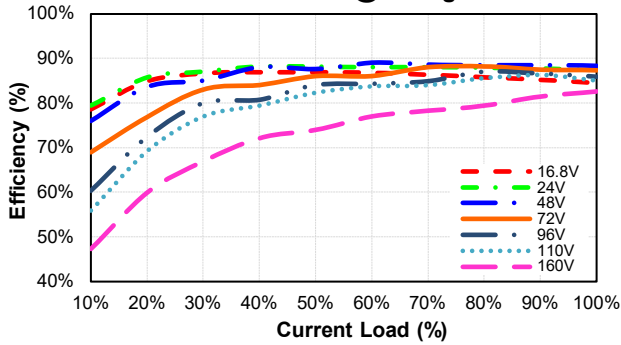

CQB50W12-72S48-CMFC
Pd Vs Po @25 Deg. C

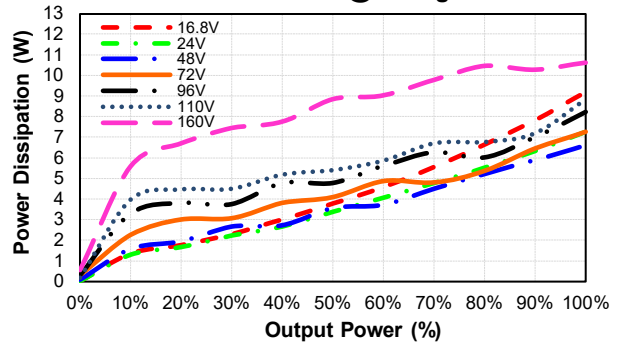



CQB50W12 CMFC(D) Series

MECHANICAL SPECIFICATION

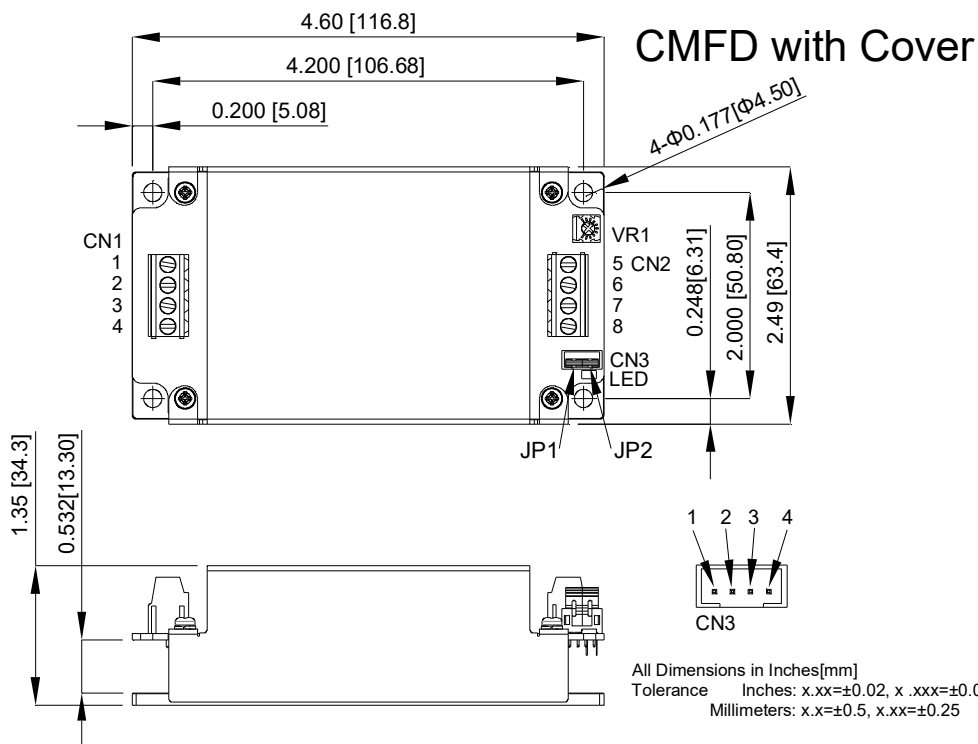
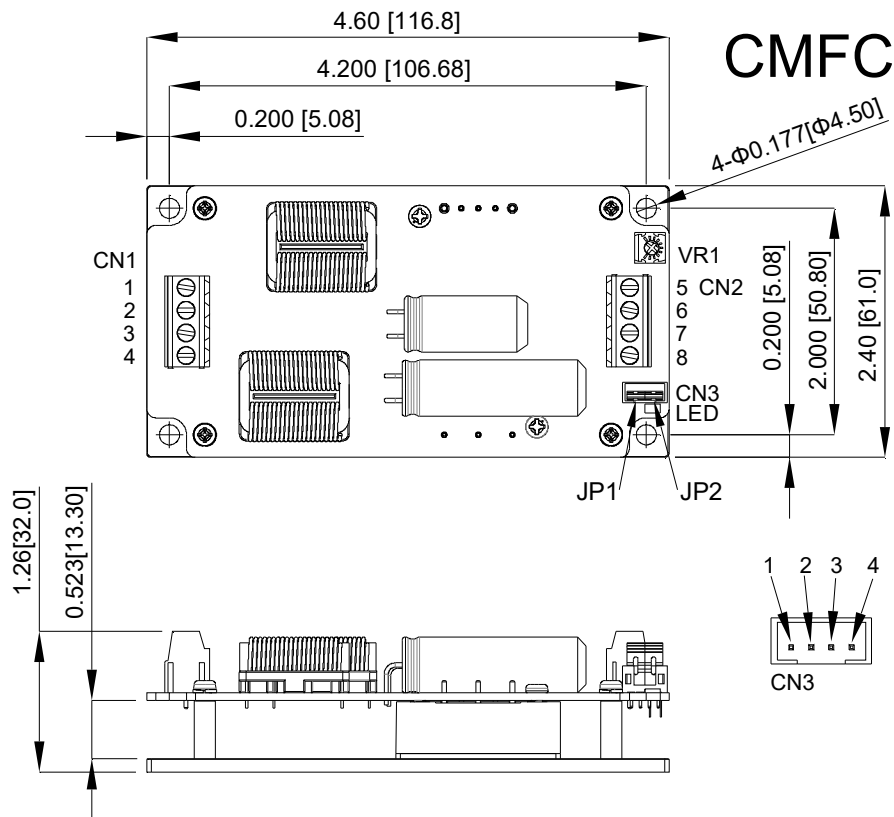

CN1 & CN2
PIN CONNECTION

PIN	Function
1	+V Input
2	-V Input
3	Remote
4	Case
5	+V Output
6	+V Output
7	-V Output
8	-V Output

CN3
PIN CONNECTION

PIN	Function
1	-V Output
2	-Sense
3	+Sense
4	+V Output

All Dimensions in Inches[mm]
Tolerance Inches: x.xx=±0.02, x.xxx=±0.010
Millimeters: x.x=±0.5, x.xx=±0.25

*JP1:Short PIN1 & PIN2
*JP2:Short PIN3 & PIN4



CQB50W12 CMFC(D) Series

MECHANICAL SPECIFICATION

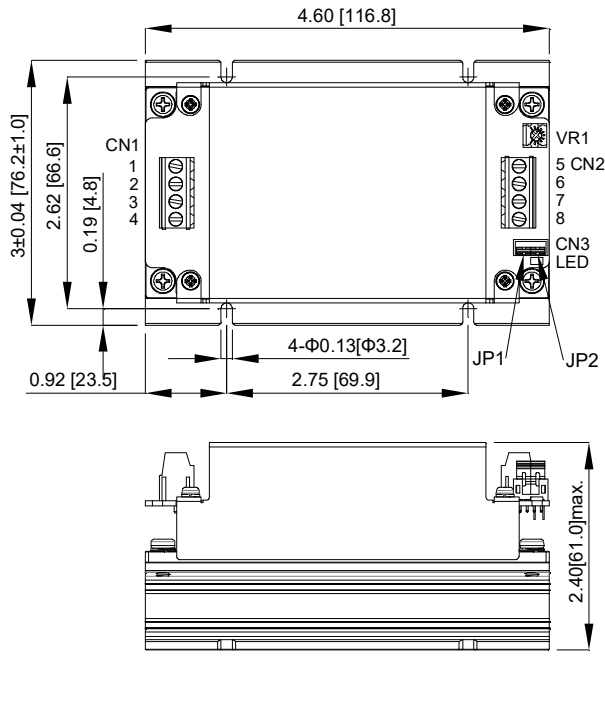

CMFD+HS

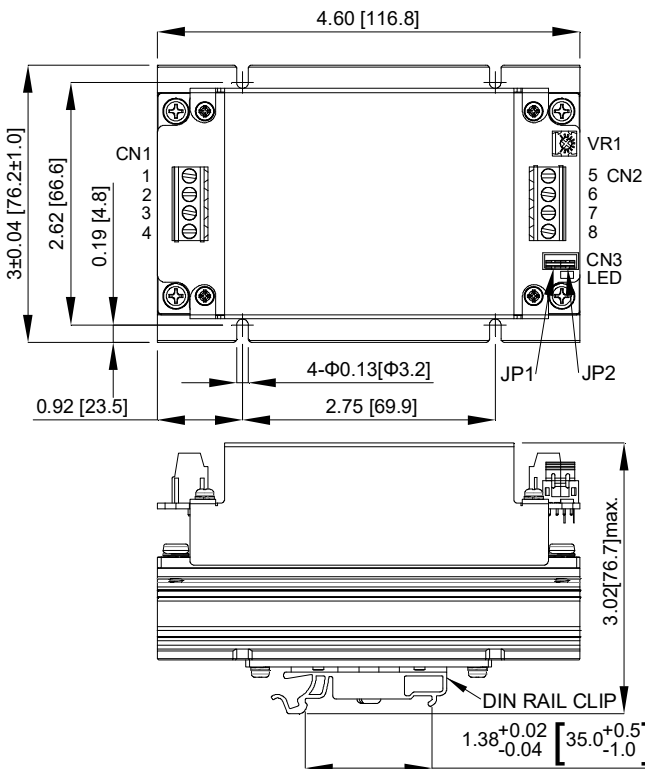
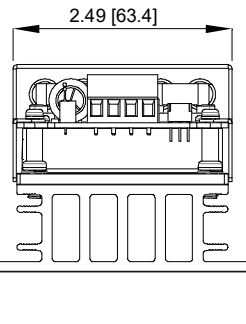
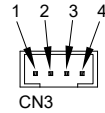

CMFD+HD

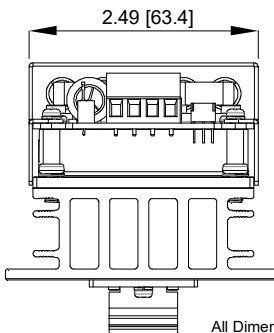
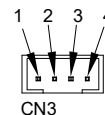

CN1 & CN2 PIN CONNECTION

PIN	Function
1	+V Input
2	-V Input
3	Remote
4	Case
5	+V Output
6	+V Output
7	-V Output
8	-V Output

CN3 PIN CONNECTION

PIN	Function
1	-V Output
2	-Sense
3	+Sense
4	+V Output

*JP1: Short PIN1 & PIN2
*JP2: Short PIN3 & PIN4

All Dimensions in Inches[mm]
Tolerance Inches: x.xx=±0.02, x.xxx=±0.010
Millimeters: x.x=±0.5, x.xx=±0.25