

# NJ30HW Series

30W 4:1 Regulated Single & Dual output



electronicpowersolutions

## Features

- Wide 4:1 Input Range
- Isolation Voltage up to 5000VAC
- Reinforced Insulation for 250Vrms Working Voltage
- Efficiency up to 89%
- Under Voltage Lockout
- Remote On/Off Control
- Adjustable Output Voltage
- Continuous Short Circuit Protection
- Over Current Protection
- Over Voltage Protection
- Over Temperature Protection



## PART NUMBER STRUCTURE

**NJ** **30** **H** **W** - **24** **05** **S**  
(1) (2) (3) (4) (5) (6) (7)

**(1) Series**

**(2) Watt**

30 - 30 W

**(3) High Isolation**

**(4) Wide Input Range**

W - 4 : 1

**(5) Input Voltage Range**

24 - 9-36 V

36 - 18-75 V

**(6) Output Voltage**

05 - 5.0 V

12 - 12 V

15 - 15 V

**(7) Output Type**

S - Single Output

D - Dual Output



ALL SPECIFICATIONS ARE TYPICAL AT 25°C, NOMINAL INPUT AND FULL LOAD UNLESS OTHERWISE NOTED

MODEL NUMBER	INPUT Voltage Range (VDC)	INPUT Current		OUTPUT Voltage (VDC)	OUTPUT Current		EFFICIENCY @FL (% , typ.)	Capacitive Load @FL (µF, max.)
		No-Load (mA, typ.)	Full Load (mA, typ.)		Min. load (mA)	Full load (mA)		
NJ30HW-2405S	9-36	10	1453	5	0	6000	86	7200
NJ30HW-2412S	9-36	10	1437	12	0	2500	87	1200
NJ30HW-2415S	9-36	10	1404	15	0	2000	89	1000
NJ30HW-2405D	9-36	10	1488	±5	0	±3000	84	±3600
NJ30HW-2412D	9-36	10	1437	±12	0	±1250	87	±750
NJ30HW-2415D	9-36	10	1404	±15	0	±1000	89	±500
NJ30HW-4805S	18-75	10	718	5	0	6000	87	7200
NJ30HW-4812S	18-75	10	710	12	0	2500	88	1200
NJ30HW-4815S	18-75	10	702	15	0	2000	89	1000
NJ30HW-4805D	18-75	10	744	±5	0	±3000	84	±3600
NJ30HW-4812D	18-75	10	718	±12	0	±1250	87	±750
NJ30HW-4815D	18-75	10	702	±15	0	±1000	89	±500

INPUT SPECIFICATIONS						
Parameter	Conditions		Min.	Typ.	Max.	Unit
Input Voltage Range	24V Input		9	24	36	VDC
	48V Input		18	48	75	
Under Voltage Lockout	24V Input	Module ON		8.2		VDC
		Module OFF		7.5		
	48V Input	Module ON		17.4		
		Module OFF		16.0		
Input Filter			Pi Type			
Input Reflected Ripple Current (1)				20		mApk-pk
Start up Time	Nominal Vin and constant resistive load			20		ms
Remote ON/OFF Control (2)	Module ON (Open Circuit)		3.0		12	VDC
	Module OFF (Short circuit pin 2 and pin 6)		0		1.2	VDC
	OFF Idle Input Current			2.5		mA
	CTRL Pin Input Current				1.0	mA
Recommended input fuse ( slow blow )	24V Input		6.3			A
	48V Input		3.15			
Note : 1. Measured with a simulated source inductance of 12µH and a source capacitor Cin ( 47µF, ESR<1.0Ω at 100 kHz ). 2. The remote on/off control pin is referenced to -Vin ( pin2 ).						

ABSOLUTE MAXIMUM RATINGS					
Parameter	Conditions	Min.	Typ.	Max.	Unit
Input Surge Voltage ( 1000 ms )	24V Input			50	VDC
	48V Input			100	
Soldering Temperature	1.5mm from case 10sec max.			260	°C

Note : These are stress ratings. Exposure of devices to any of these conditions may adversely affect long-term reliability.

OUTPUT SPECIFICATIONS					
Parameter	Conditions	Min.	Typ.	Max.	Unit
Output Voltage Accuracy		-1.0		+1.0	%
Output Voltage Adjustability ( Trim )	Single Output	-10		+10	%
Line Regulation	Single Output	-0.2		+0.2	%
	Dual Output	-0.5		+0.5	
Load Regulation	From 0% to 100% Load	Single Output	-0.5	+0.5	%
		Dual Output	-1.0	+1.0	
Cross Regulation	Asymmetrical Load 25% / 100% for Dual Output	-5		+5	%
Ripple & Noise(1)	20MHz bandwidth	5V Output		50	mVpk-pk
		12V & 15V Output		75	
Over Voltage Protection (Zener diode clamp)	5V Output		6.2		VDC
	12V Output		15		
	15V Output		18		
Over Current Protection			150		% of FL
Short Circuit Protection		Indefinite ( hiccup ) ( Automatic Recovery )			
Temperature Coefficient		-0.02		+0.02	%/°C
Capacitive Load	Minimum Vin and constant resistive load	See Table			
Transient Recovery Time	Nominal Vin and 25% load step change ( 75%-50%-25% of Io )		250		µs
Transient Response Deviation		5V Output		5	
	12V & 15V Output		3		

Note :  
1. Measured With a 10µF ceramic capacitor.

GENERAL SPECIFICATIONS					
Parameter	Conditions	Min.	Typ.	Max.	Unit
Isolation Voltage	Input-output, and rated for 60sec	5000			VAC
Isolation Resistance	Input-output	1000			MΩ
Isolation Capacitance	Input-output		20		pF
Clearance / Creepage	Input-output	8			mm
Leakage Current	240VAC,60Hz		2		µA
Switching Frequency			275		k Hz
MTBF	MIL-HDBK-217 F @ 25°C	300			k hours
Safety Standard	IEC / EN / UL 62368-1	DK-136001-UL, E252573			
Insulation System		Reinforced Insulation			
Environmental compliance		RoHS			

ENVIRONMENT SPECIFICATIONS					
Parameter	Conditions	Min.	Typ.	Max.	Unit
Operating Ambient Temperature	See the Derating Curve	-40		100	°C
Maximum Case Temperature				105	°C
Thermal Impedance		11			°C/W
Over Temperature Protection	Case Temperature		115		°C
Storage Humidity				95	% rel. H
Storage Temperature		-55		125	°C
Cooling	Nature Convection	30-65 LFM			

EMC SPECIFICATIONS			
Parameter	Standard	Condition	Criterion
Conducted Emissions	EN55032	without external components	A
Radiated Emissions	EN55032	without external components	A
ESD	IEC 61000-4-2	Air ± 15kV, Contact ± 8kV	A
RS	IEC 61000-4-3	10V/m	A
EFT	IEC 61000-4-4	±2kV with external components	A
Surge	IEC 61000-4-5	±2kV with external components	A
CS	IEC 61000-4-6	10Vrms	A
PFMF	IEC 61000-4-8	100A/m	A

PHYSICAL SPECIFICATIONS	
Parameter	Value
Case Material	Nonconductive Black Plastic ( UL94V-0 rated )
Base Material	Nonconductive Black Plastic ( UL94V-0 rated )
Pin Material	Φ1.0mm Brass Solder-coated
Potting Material	Silicone ( UL94V-0 rated )
Weight	30 g, typ.
Dimensions	2.00" x 1.00" x 0.40"

**ELECTRICAL CHARACTERISTIC CURVES**

**Derating Curve**

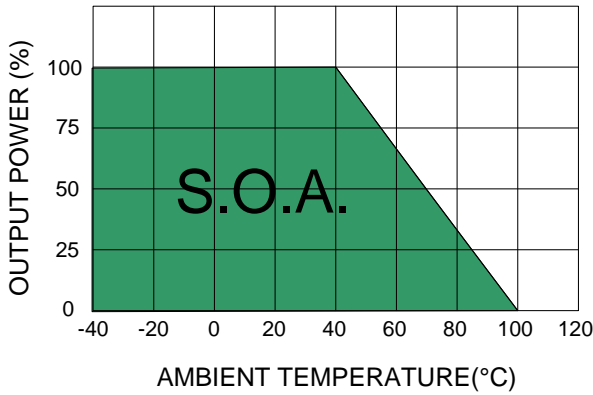

**Dual Output 5V Models**

**Derating Curve**

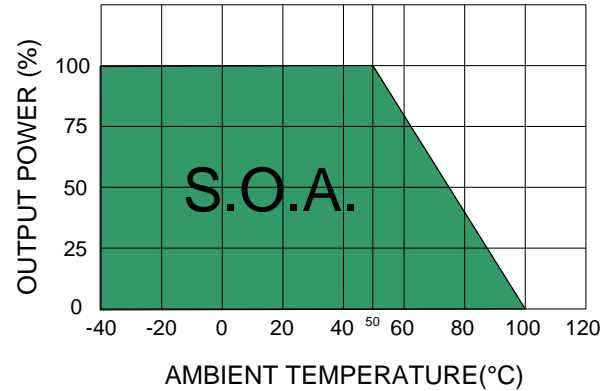

**Single Output 5V Models**

**Derating Curve**

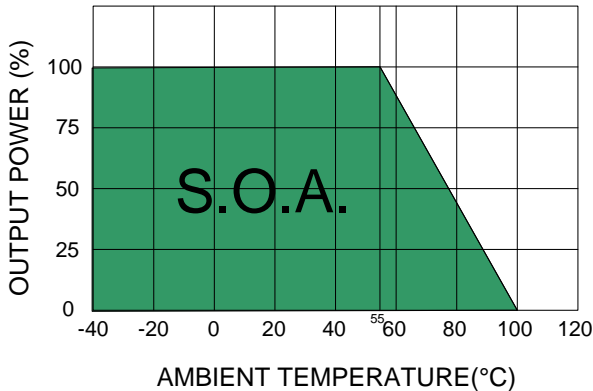

**Single & Dual Output 12V Models**

**Derating Curve**

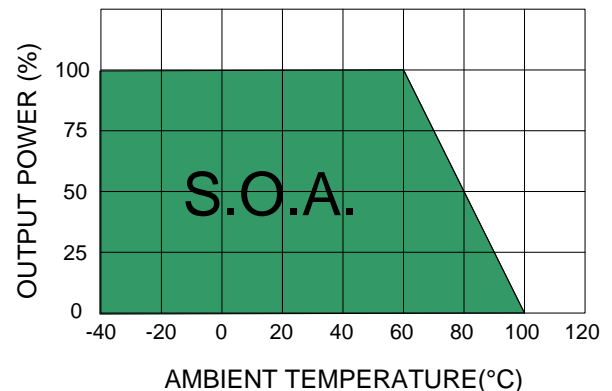

**Single & Dual Output 15V Models**

**TEST CONFIGURATIONS**

**Input Reflected Ripple Current Test Step**

Input reflected ripple current is measured with a source inductor  $L_{in}$  (12 $\mu$ H) and a source capacitor  $C_{in}$  (47 $\mu$ F, ESR<1.0 $\Omega$  at 100KHz) at nominal input and full load.

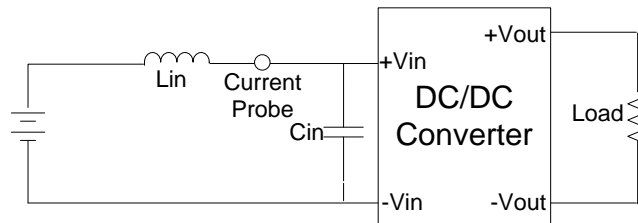

**DESIGN & FEATURE CONFIGURATIONS**

**Over Current Protection**

The module includes an internal over current protection circuit, which will endure current limiting for an unlimited duration during output over load condition. If the output current exceeds the OCP set point, the module will shut down automatically (hiccup). The module will try to restart after shut down. If the over load condition still exists, the module will shut down again.

**Over Voltage Protection**

The module includes an internal output over voltage protection circuit, which monitors the voltage on the output terminals. If this voltage exceeds the over voltage set point, the module will activate the control loop of internal circuit to clamp the output voltage.

**Over Temperature Protection Test**

The over temperature protection consists of circuitry that provides protection from thermal damage. If the temperature exceeds the over temperature threshold the module will shut down. The module will try to restart after shut down, if the over temperature condition still exists during restart, the module will shut down again. This restart trial will continue until the temperature is within specification.

**Remote Module ON / OFF**

Positive logic turns on the module during high logic and off during low logic. Remote module on/off can be controlled by an external switch between the CTRL terminal and -Vin terminal. For positive logic if the remote feature is not used, please leave the CTRL pin floating.

**EMC Filter**

The Circuit is used to meet Surge & EFT test.

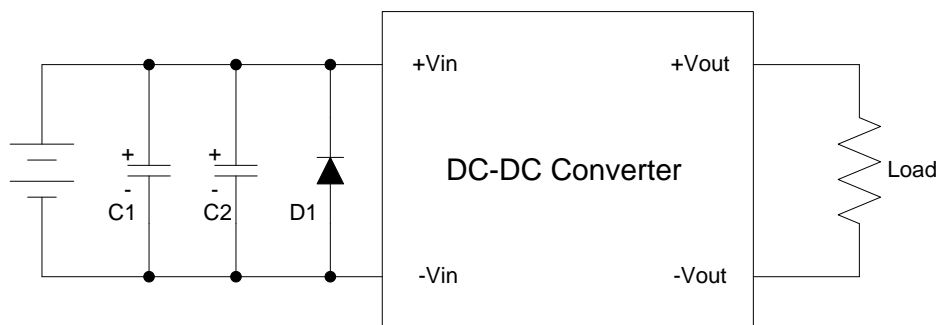

	C1、C2 NIPPON Chemi-con KY Series	D1
NJ30HW-24XXX	470uF, 100V	SMDJ58A
NJ30HW-48XXX	220uF, 100V	SMDJ120A

**MECHANICAL SPECIFICATIONS**

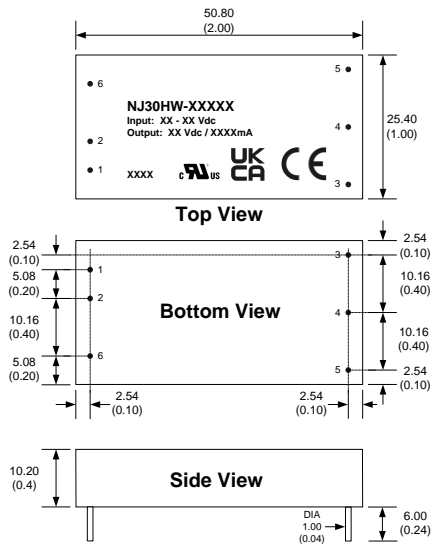

- Notes : All dimensions are typical in millimeters ( inches ).
1. Pin diameter: 1.0±0.05 ( 0.02±0.002 )
  2. Pin pitch and length tolerance: ±0.35 ( ±0.014 )
  3. Case Tolerance: ±0.5 ( ±0.02 )

PIN CONNECTIONS		
PIN NUMBER	SINGLE	DUAL
1	+Vin	+Vin
2	-Vin	-Vin
3	+Vout	+Vout
4	-Vout	COM
5	Trim	-Vout
6	CTRL	CTRL

**EXTERNAL OUTPUT TRIMMING**

Output can be externally trimmed by using the method as below. (single output models only )

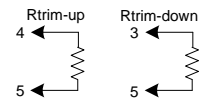

**RECOMMEND FOOTPRINT DETAILS**

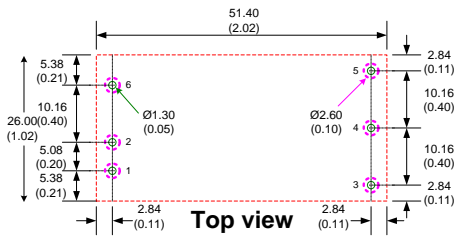

- Notes : 1. All dimensions are typical in mm (inches).
- Through hole 1 ~ 6: Ø 1.30 (0.051)
  - Top view pad 1 ~ 6: Ø 1.50 (0.059)
  - Bottom view pad 1 ~ 6: Ø 2.60 (0.102)
2. There should be at least 8mm distance between primary and secondary circuit.